

承認書

Specification For Approval

Customer: (客戶)

Description: (產品描述) **SMDLED2012**

Part number: (產品型號) **TJ-S2012RK08A21HQYJYK6-A3**

Date: (日期)

Approved By: (客戶承認)

--

Prepared By: (我司承認)

Approval	Check	Design	Sales

核准

審核

製作

業務

Customer Service Hotline: **400-676-8616**

TEL: 0769-8662 5999 0769-8200 2226

FAX: 0769-8200 2227

E-MAIL : dg@togialed.com

WEB: www.togialed.com

Features

- 2.0mm x 1.25mm SMT LED, 0.8mm thickness
- Low power consumption
- Wide view angle
- Package: 3000pcs/reel
- RoHS Compliant

Applications

- Ideal for back light and indicator
- Various colors and lens types available

Package outlines

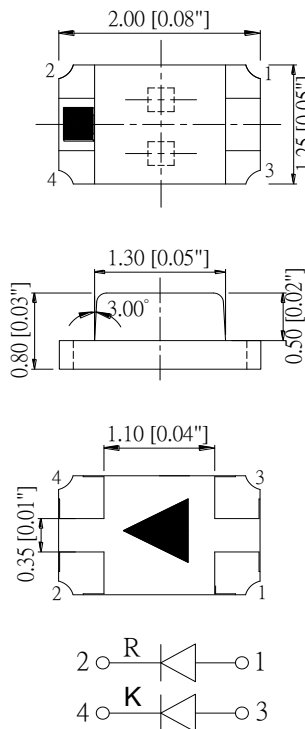

Recommend Pad Layout

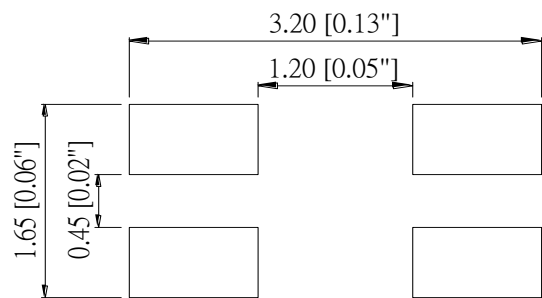

Part No.	Emitted color	Dice	Lens color
TJ-S2012RK08A21HQYJYK6-A3	Red	AlGaInP	Water transparent
	Green	InGaN/GaN	

Notes:

1. All dimensions are in millimeters (inches);
2. Tolerances are $\pm 0.1\text{mm}$ (0.004inch) unless otherwise noted.

Absolute maximum ratings (TA=25°C)

Parameter	Symbol	Value		Unit
		R	K	
Power dissipation	Pd	72	60	mW
Forward current	If	30		mA
Reverse voltage	Vr	5		V
Operating temperature	Top	-40 ~+80		°C
Storage temperature	Tstg	-40 ~+85		°C
Peak pulsing current (1/8 duty f=1kHz)	Ifp	125		mA

Electro-optical characteristics (TA=25°C)

Parameter	Test Condition	Symbol	Value			Unit	
			Min	Typ	Max		
Wavelength at peak emission	If=20mA	λ_p	R	--	630	--	nm
			K	--	575	--	
Spectral half bandwidth	If=20mA	$\Delta \lambda$	R	--	18	--	nm
			K	--	28	--	
Dominant wavelength	If=20mA	λ_d	R	620	--	630	nm
			K	565	--	575	
Forward voltage	If=20mA	Vf	R	1.8	--	2.4	V
			K	1.8	--	2.4	
Luminous intensity	If=20mA	Iv	R	80	--	200	mcd
			K	35	--	70	
Viewing angle at 50% Iv	If=10mA	2 θ 1/2	--	120	--	Deg	
Reverse current	Vr=5V	Ir	--	--	10	μ A	

Optical characteristic curves(Red)

Relative Intensity vs. Wavelength

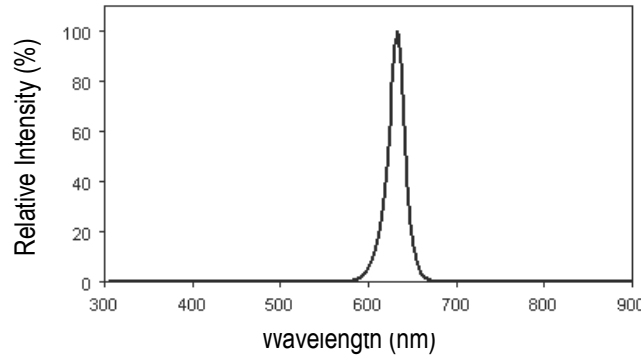

Forward Current vs. Forward Voltage

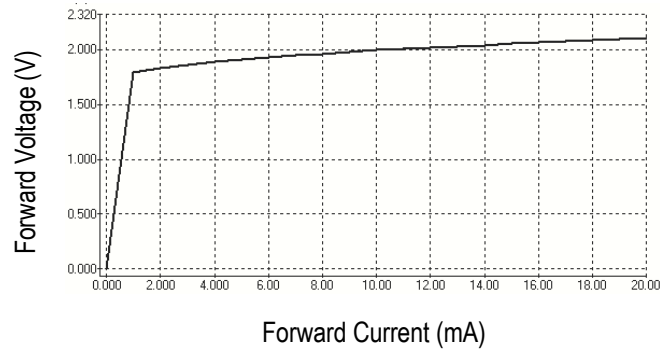

Directive Characteristics

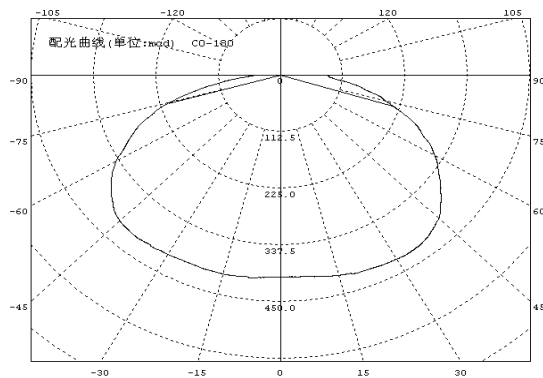

Optical characteristic curves (Green)

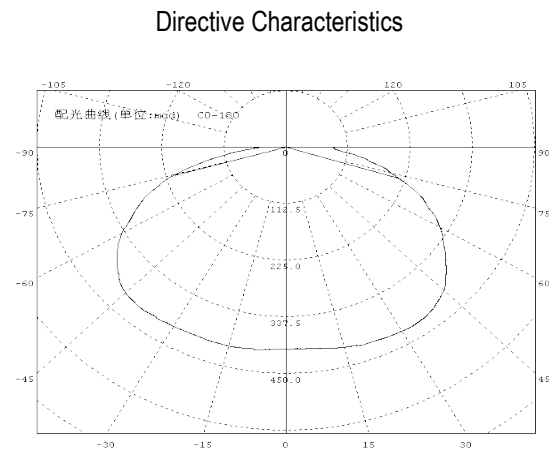
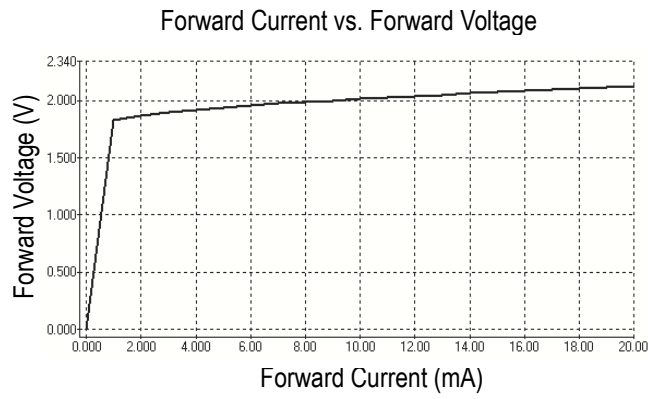
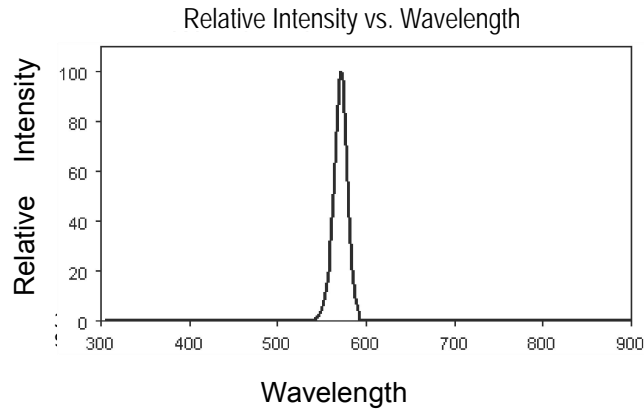

Reflow Profile

■ Reflow Temp/Time

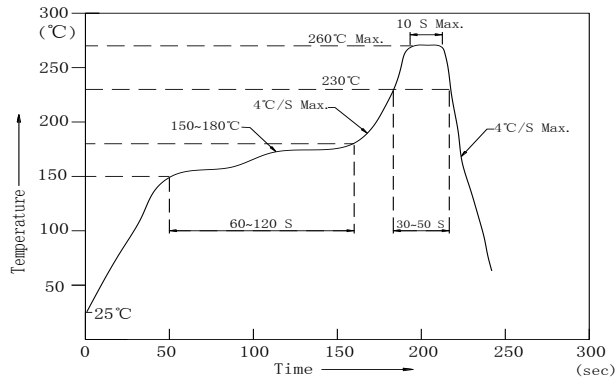

Notes:

1. We recommend the reflow temperature 245°C (±5°C). the maximum soldering temperature should be limited to 260°C. TOG(A)LED
2. Don't cause stress to the epoxy resin while it is exposed to high temperature.
3. Number of reflow process shall be 2 times or less.

■ Soldering iron

Basic spec is $\leq 5\text{sec}$ when 320°C (±20°C). If temperature is higher, time should be shorter (+10°C → -1sec). Power dissipation of iron should be smaller than 20W, and temperatures should be controllable. Surface temperature of the device should be under 350°C.

■ Rework

1. Customer must finish rework within 5 sec under 340°C.
2. The head of iron cannot touch copper foil
3. Twin-head type is preferred.

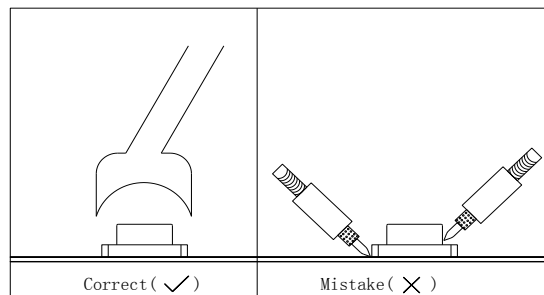

- Avoid rubbing or scraping the resin by any object, during high temperature, for example reflow solder etc.

Test circuit and handling precautions

■ Test circuit

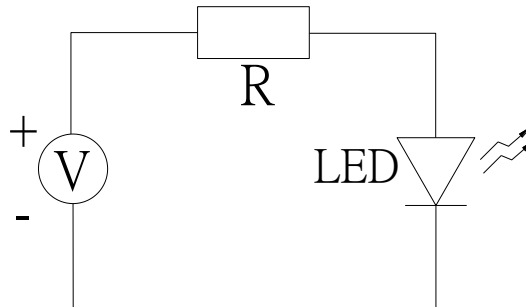

■ Handling precautions

1. Over-current-proof

Customer must apply resistors for protection; otherwise slight voltage shift will cause big current change (Burn out will happen). TOGIALED

2. Storage

2.1 It is recommended to store the products in the following conditions:

Humidity: 60% R.H. Max.

Temperature : 5°C~30°C (41°F ~86°F)

2.2 Shelf life in sealed bag: 12 month at <5°C~30°C and <30% R.H. after the package is Opened, the products should be used within a week or they should be keeping to stored at ≤ 20 R.H. with zip-lock sealed.

3. Baking

It is recommended to baking before soldering when the pack is unsealed after 72hrs. The Conditions are as followings:

3.1 $60 \pm 3^\circ\text{C}$ x(12~24hrs) and <5%RH, taped reel type

3.2 $100 \pm 3^\circ\text{C}$ x(45min~1hr), bulk type

3.3 $130 \pm 3^\circ\text{C}$ x(15~30min), bulk type

Test items and results of reliability

Type	Test Item	Test Conditions	Note	Number of Damaged
Environmental Sequence	Temperature Cycle	-20°C 30min ↑ ↓ 80°C 30min	100 cycle	0/22
	Thermal Shock	-20°C 15min ↑ ↓ 80°C 15min	100 cycle	0/22
	High Humidity Heat Cycle	30°C ↔ 65°C 90%RH 24hrs/1cycle	10 cycle	0/22
	High Temperature Storage	Ta=80°C	1000 hrs	0/22
	Humidity Heat Storage	Ta=60°C RH=90%	1000 hrs	0/22
	Low Temperature Storage	Ta=-30°C	1000 hrs	0/22
Operation Sequence	Life Test	Ta=25°C IF=20mA	1000 hrs	0/22
	High Humidity Heat Life Test	60°C RH=90% IF=10mA	500 hrs	0/22
	Low Temperature Life Test	Ta=-20°C IF=20mA	1000 hrs	0/22

2012 Series SMD Chip LED Lamps Packaging Specifications

- Feeding Direction

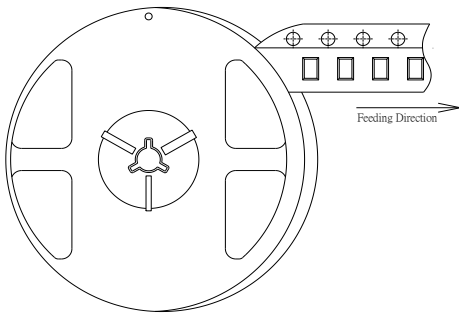

- Dimensions of Reel (Unit: mm)

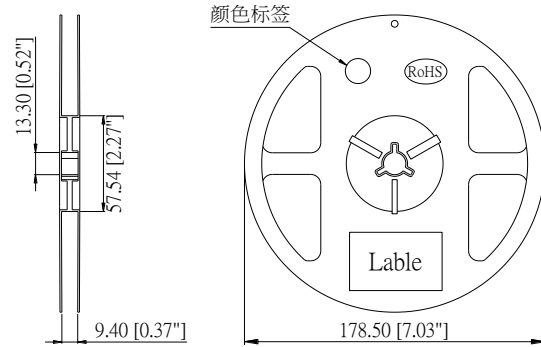

- Dimensions of Tape (Unit: mm)

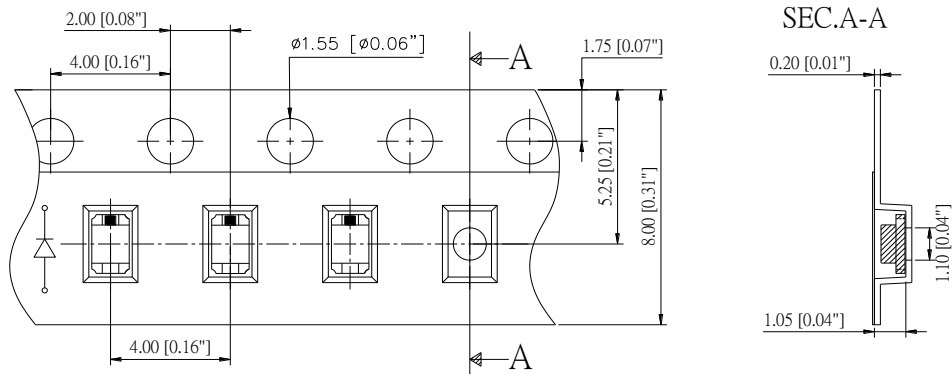

- Arrangement of Tape

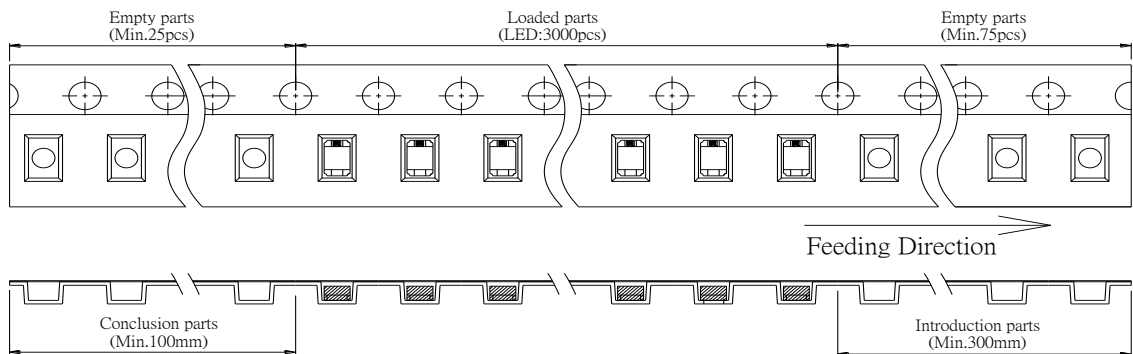

Notes:

1. Empty component pockets are sealed with top cover tape;
2. The maximum number of missing lamps is two;
3. The cathode is oriented towards the tape sprocket hole in accordance with ANSI/EIA RS-481 specifications.
4. 3,000 pcs/Reel.

