

Features

- High Density Cell Design for Ultra Low $R_{DS(on)}$
- Exceptional On-Resistance and Maximum DC Current Capability
- Epoxy Meets UL 94 V-0 Flammability Rating
- Moisture Sensitivity Level 1
- Halogen Free. "Green" Device (Note 1)
- Lead Free Finish/RoHS Compliant ("P" Suffix Designates RoHS Compliant. See Ordering Information)

Maximum Ratings

- Operating Junction Temperature Range : -55°C to +150°C
- Storage Temperature Range: -55°C to +150°C
- Thermal Resistance: 96°C/W Junction to Ambient

Parameter	Symbol	Rating	Unit
Drain-Source Voltage	V_{DS}	-30	V
Gate-Source Voltage	V_{GS}	±12	V
Continuous Drain Current	I_D	-4.2	A
Pulsed Drain Current	I_{DM}	-30	A
Total Power Dissipation	P_D	1.3	W

Note: 1. Halogen free "Green" products are defined as those which contain <900ppm bromine, <900ppm chlorine (<1500ppm total Br + Cl) and <1000ppm antimony compounds.

Internal Structure

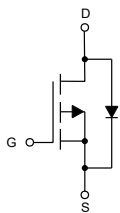

1. GATE
2. SOURCE
3. DRAIN

Marking: R1A.

**P-CHANNEL
MOSFET**

SOT-23

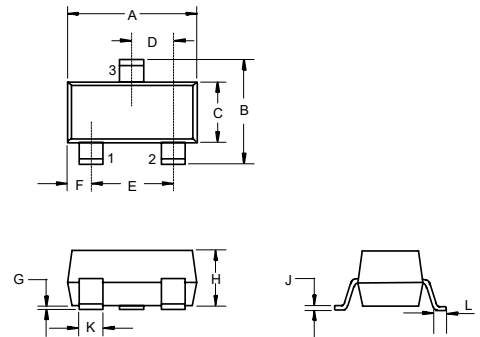

DIM	DIMENSIONS				NOTE
	INCHES		MM		
	MIN	MAX	MIN	MAX	
A	0.110	0.120	2.80	3.04	
B	0.083	0.104	2.10	2.64	
C	0.047	0.055	1.20	1.40	
D	0.034	0.041	0.85	1.05	
E	0.067	0.083	1.70	2.10	
F	0.018	0.024	0.45	0.60	
G	0.0004	0.006	0.01	0.15	
H	0.035	0.043	0.90	1.10	
J	0.003	0.007	0.08	0.18	
K	0.012	0.020	0.30	0.51	
L	0.007	0.020	0.20	0.50	

Suggested Solder Pad Layout

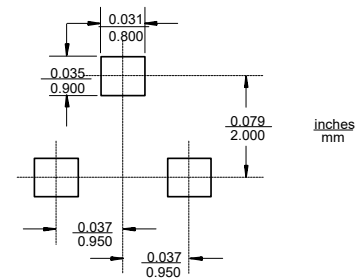

Electrical Characteristics @ 25°C (Unless Otherwise Specified)

Parameter	Symbol	Test Conditions	Min	Typ	Max	Unit
Off Characteristics						
Drain-Source Breakdown Voltage	$V_{(BR)DSS}$	$V_{GS}=0V, I_D=-250\mu A$	-30			V
Zero Gate Voltage Drain Current	I_{DSS}	$V_{DS}=-24V, V_{GS}=0V$			-1	μA
Gate-Source Leakage Current	I_{GSS}	$V_{DS}=0V, V_{GS}=\pm 12V$			± 100	nA
On Characteristics (Note 2)						
Gate-Threshold Voltage	$V_{GS(th)}$	$V_{DS}=V_{GS}, I_D=-250\mu A$	-0.7		-1.3	V
Drain-Source On-Resistance	$R_{DS(on)}$	$V_{GS}=-10V, I_D=-4.2A$		41	60	m Ω
		$V_{GS}=-4.5V, I_D=-4A$		47	70	
		$V_{GS}=-2.5V, I_D=-1A$		61	85	
Forward Transconductance	g_{FS}	$V_{DS}=-5V, I_D=-5A$	7			S
Dynamic Characteristics (Note 3)						
Input Capacitance	C_{iss}	$V_{DS}=-15V, V_{GS}=0V, f=1MHz$		1050		pF
Output Capacitance	C_{oss}			127		
Reverse Transfer Capacitance	C_{rss}			85		
Switching Characteristics (Note 3)						
Turn-On Delay Time	$t_{d(on)}$	$V_{GS}=-10V, V_{DS}=-15V, R_L=3.6\Omega, R_{GEN}=6\Omega$			6.5	ns
Turn-On Rise Time	t_r				3.5	
Turn-Off Delay Time	$t_{d(off)}$				40	
Turn-Off Fall Time	t_f				13	
Drain-Source Diode Characteristics and Maximum Ratings						
Diode Forward Voltage (Note 1)	V_{SD}	$V_{GS}=0V, I_S=-1A$			-1	V

 Note: 2. Pulse Test : Pulse Width $\leq 300\mu s$, Duty Cycle $\leq 2\%$.

3. Guaranteed by Design, Not Subject to Production Testing.

Curve Characteristics

Fig. 1 - Output Characteristics

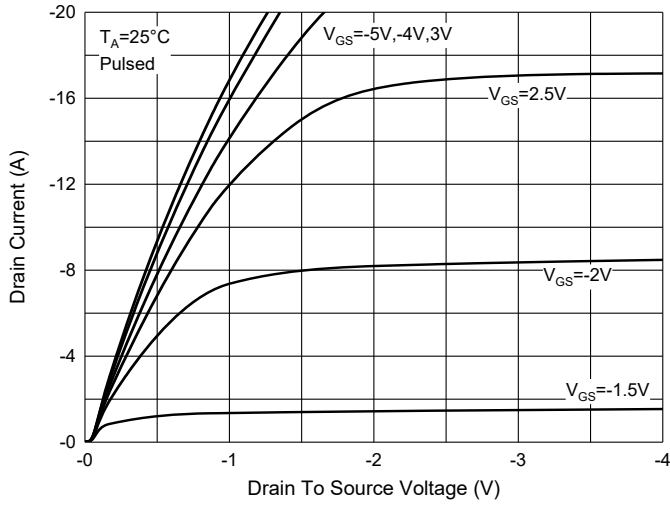

Fig. 2 - Transfer Characteristics

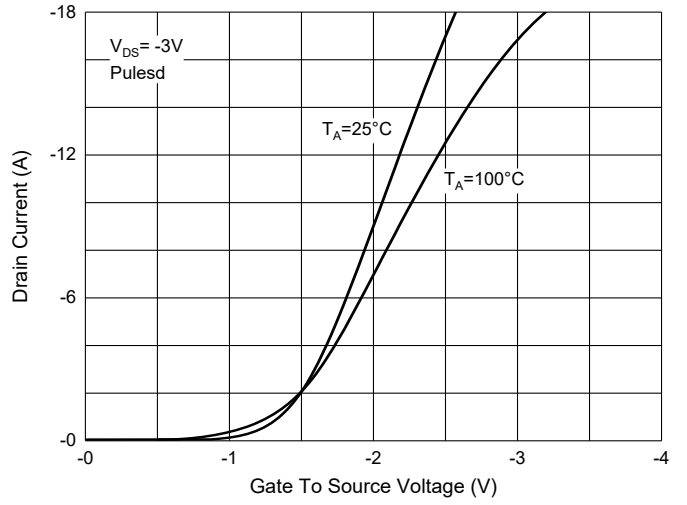

Fig. 3 - $R_{DS(ON)} - I_D$

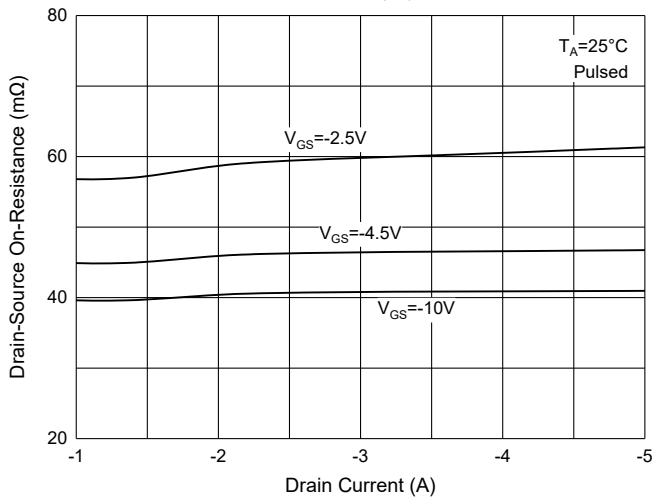

Fig. 4 - $R_{DS(ON)} - V_{GS}$

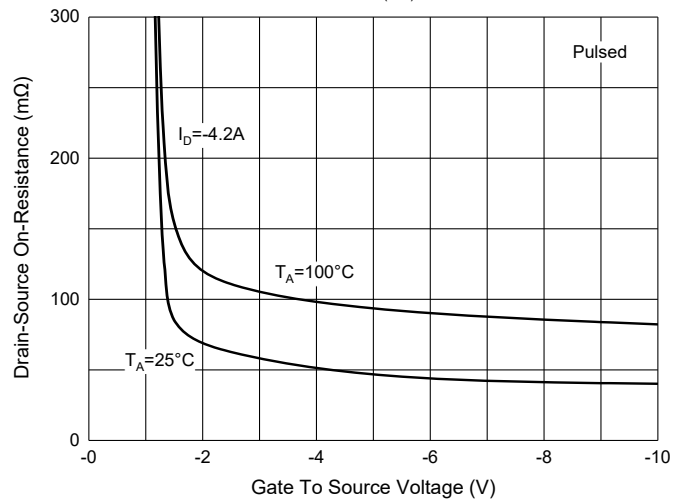

Fig. 5 - $I_S - V_{SD}$

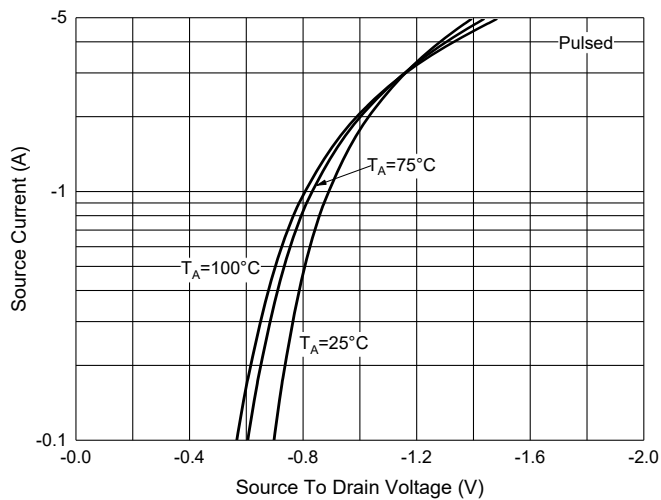
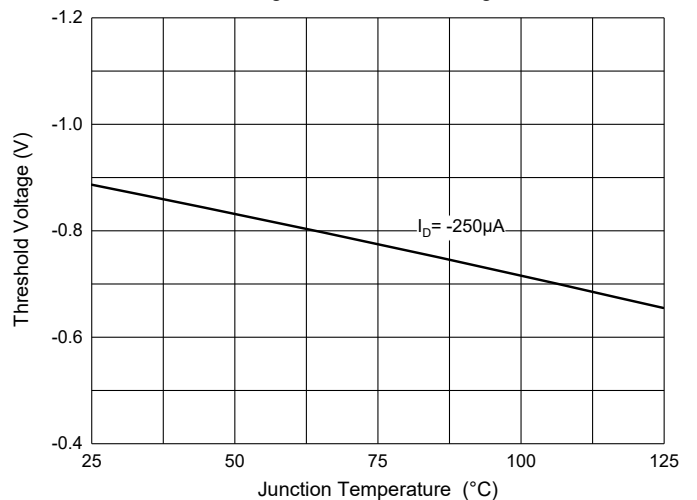
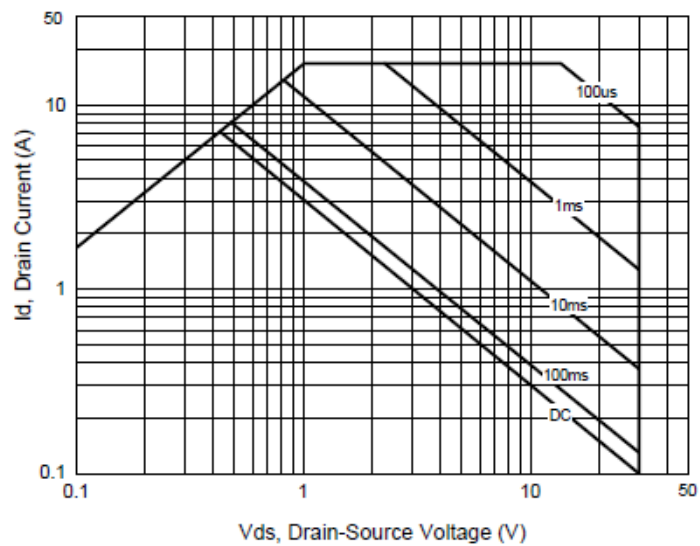

Fig. 6 - Threshold Voltage



Curve Characteristics

Fig. 7 - Safe Operation Area



Ordering Information

Device	Packing
Part Number-TP	Tape&Reel: 3Kpcs/Reel

*****IMPORTANT NOTICE*****

Micro Commercial Components Corp. reserves the right to make changes without further notice to any product herein to make corrections, modifications, enhancements, improvements, or other changes. *Micro Commercial Components Corp.* does not assume any liability arising out of the application or use of any product described herein; neither does it convey any license under its patent rights, nor the rights of others. The user of products in such applications shall assume all risks of such use and will agree to hold *Micro Commercial Components Corp.* and all the companies whose products are represented on our website, harmless against all damages. *Micro Commercial Components Corp.* products are sold subject to the general terms and conditions of commercial sale, as published at <https://www.mccsemi.com/Home/TermsAndConditions>.

*****LIFE SUPPORT*****

MCC's products are not authorized for use as critical components in life support devices or systems without the express written approval of Micro Commercial Components Corporation.

*****CUSTOMER AWARENESS*****

Counterfeiting of semiconductor parts is a growing problem in the industry. Micro Commercial Components (MCC) is taking strong measures to protect ourselves and our customers from the proliferation of counterfeit parts. MCC strongly encourages customers to purchase MCC parts either directly from MCC or from Authorized MCC Distributors who are listed by country on our web page cited below. Products customers buy either from MCC directly or from Authorized MCC Distributors are genuine parts, have full traceability, meet MCC's quality standards for handling and storage. **MCC will not provide any warranty coverage or other assistance for parts bought from Unauthorized Sources.** MCC is committed to combat this global problem and encourage our customers to do their part in stopping this practice by buying direct or from authorized distributors.