

Chengx[®]

东莞市承兴电子有限公司

DONG GUAN SHI CHENG XING ELECTRONICS CO.,LTD

承 认 书

客户名称: _____

客户料号: _____

零件名称: 铝电解电容器

承兴料号: GR Series

承认规格: 见附档

制作日期: 2021年2月3日

承办单位: 工程部

版 本: A-0

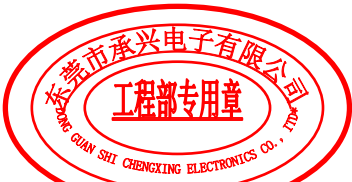
| 盖章处 | 核 准 | 审 核 | 制 作 |
|---|-----|-----|-----|
|  | 王根林 | 刘蜜 | 刘蜜 |

公司地址: 广东省东莞市长安镇沙头沙区裕成路1号承兴高新科技园

TEL: (0769)81604900、81604911、81604922

FAX: (0769)85648558、85498863

| 客户承认栏 Approved by | | | |
|----------------------|-----|-----|-----|
| 盖章处 | 核 准 | 审 核 | 承 办 |
| | | | |

承认盖章后请回传, 感谢!

No.: CX-YX-0910-2.0

铝电解电容使用注意事项：

1、电路设计

- (1) 在确认使用及安装环境时,作为按产品样本设计说明书所规定的额定性能范围内使用电容器,应当避免在下述情况下使用:
- a) 高温(温度超过最高使用温度);
 - b) 过流(电流超过额定纹波电流);
 - c) 过压(电压超过额定电压);
 - d) 施加反向电压或交流电压;
 - e) 使用于反复多次急剧充放电的电路中。

另：1、在电路设计时,请选用与机器寿命相当的电容器。

2、机器性能有特殊要求时,可与研发人员探讨,制造适用的特规电容。

- (2) 电容器外壳,辅助引出端子与正负以及电路析间必须完全隔离。
- (3) 当电容器套管的绝缘不能保证时,在有绝缘性能特定要求的地方,请不要使用。

(4) 请不要在下述环境下使用电容器:

- a) 直接与水,盐水及油类相接触,或结露的环境;
- b) 充满有害气体的环境(硫化物,H₂SO₃,HNO₃,CL₂,氨水等);
- c) 置于日照,O₃,紫外线及有放射性物质的环境;
- d) 振动及冲击条件超过了样本及说明书的规定范围的恶劣环境。

(5) 在设计电容器的安装时,必须确认下述内容:

- a) 电容器的正负极间距必须与线路板孔距吻合;
- b) 保证电容器防爆阀上方留有一定的空间;
- c) 电容器防爆上方尽量避免配线及安装其它元器件;
- b) 电路板上,电容器的安装位置,请不要有其它配线;
- e) 电容器四周及电路板上尽量避免设计,安装发热组件。

(6) 另外,在设计电器时,必须确认以下内容:

- a) 温度及频率的变化不至于引起电性能变化;
- b) 双面印刷板上安装电容器时,电容器的安装位置避免多余的基板孔和过孔;
- c) 两只以上的电容器并联连接时电流均衡;
- d) 两只以上的电容器串联连接时电压均衡。

2、组件安装

(1) 安装时,请遵守以下内容:

- a) 为了对电容器进行点检,测定电气性能时,除了卸下的电容器,装入机器中通过电的电容器 请不要再使用;
- b) 当电容器产生再生电压时,需通过约1KΩ左右的电阻进行放电;
- c) 长期保存的电容器,需通过约1KΩ左右的电阻加压处理;
- d) 确认规格(静电容量及额定电压等)及极性后,再安装;
- e) 不要讓電容器掉到地上,掉下的電容器請不要再使用;
- f) 变形的電容器不要再安裝;
- g) 電容器正负极间距与電路板孔必須吻合;
- h) 自動插入機的机械手力量不宜過大。

(2) 焊接時,請確認下面內容

- a) 注意不要將焊錫附著在端子以外;
- b) 焊接條件(溫度,時間,次數)必須按規定說明執行;
- c) 不要將電容器本身浸入焊錫溶液中;
- d) 焊接時,不要讓其它產品倒下碰到電容器上。

(3) 焊接后处理应不产生以下机械应力

- a) 电容器发生倾倒,扭转;
- b) 电容器碰到其它的线路板;
- c) 使其其它的物体碰撞到电容器。

(4) 电容器不要用洗净剂洗净,但是在有必要洗净的情况下对电容器进行洗净,必须在产品规格书规定范围内进行。

(5) 对有必要洗净的电容器,洗净时,必须确认以下内容:

- a) 洗净剂污染管理(电导率,PH值,比重,水分等);
- b) 洗净后,不能保管在洗净液环境中及密闭容器中,要采用(最高使用温度以下的)热风干燥印刷电路板及电容器,使之不残留洗净液成份。

(6) 不使用含卤素的固定剂,树脂涂层剂。

(7) 使用固定剂,涂层剂,请确认以下内容:

- a) 电路板与电容器之间,不能残留焊接残渣及污垢;
- b) 固定剂,涂层剂吸附前,尽可能不残留洗净成份,进行干燥处理,使印刷孔不堵塞。

(8) 螺栓产品安装,竖直安装时,压力阀朝上,横向安装时,保证压力阀或正极端子朝上。

3、组装使用

(1) 组装使用中,电容器的端子间不要直接接触,另外,不要让导体物质引起正负极短路。

(2) 请确认所安装电容器处的环境:

- a) 不要与水或油污接触或处于结露状态;
- b) 不要让曝光,O₃,紫外线及放射线直接照射到电容器上;
- c) 不要处于充满有害气体的环境(硫化氢,亚硫酸,亚硝酸,氯水CL₂等);
- d) 震动及冲击不要超过样本或规格说明书中规定。

4、保守点检

工厂企业用的电容器,必须定期点检,定期点检项目包括外观检查及性能的测试。

5、意外情况

- (1) 组装过程中,如电容防爆阀打开,请切断组装主电源或拔下电源插头。
- (2) 电容器防爆阀动作时,因有超过100℃高温气体喷出,脸不要接近,喷出气体进入眼睛时,立即用清水清洗眼睛。不要尝电容器的电解液,电解液 溅到皮肤上时,用肥皂清洗。

6、熏蒸处理

当组装电容器的电子产品出口到海外时,用溴化钾等卤化物进行熏蒸处理,因此方法可能会产生因卤素离子而引起的腐蚀反应,请务小心;熏蒸时,熏蒸液不能直接接触电子产品,同时有必要进行充分干燥处理,估计有熏蒸液附者及干燥不充分时,有必要先查询一下安全性。

7、储存条件

- (1) 在温度为5-30℃,湿度为75%以下的室内储存。
- (2) 不要保存在组装使用中禁用的环境及同等条件下。

8、报废情况

废弃的電容器,可任选下面一种方法进行处理:

- (1) 電容器上开孔或压碎后焚烧。
- (2) 電容器不焚烧时,交給专职废品回收人员进行处理。

Part Number System (产品编码)

| 1 | | 2 | | 3 | | 4 | | 5 | | 6 | | 7 | | 8 | | 9 | | 10 | | 11 | | 12 | | 13 | | 14 | | 15 | | 16 | | 17 | | 18 | | 19 | | 20 | | 21 | |
|--------|-----------|------------|-----------|------|---------|---------|-----------|-----------|--------------|-----------------|------------|--------------------|---------|---------------------|----|-------|--|--------|--|----|--|----|--|----|--|----|--|----|--|----|--|----|--|----|--|----|--|----|--|----|--|
| SERIES | | CAPCITANCE | | TOL. | | VOLTAGE | | CASE SIZE | | TYPE | | SLEEVE | | COLOR | | SHAPE | | OTHERS | | | | | | | | | | | | | | | | | | | | | | | |
| Series | Cap (MFD) | Code | Tolerance | Code | Voltage | Code | Case Size | | Feature Code | | Background | Code | Special | Code | | | | | | | | | | | | | | | | | | | | | | | | | | | |
| | | | | | | | Liameten | Code | | | | | | | | | | | | | | | | | | | | | | | | | | | | | | | | | |
| LG | LR | 0.1 | 104 | ±5% | J | 004 | 4 | 3 | B | Bulk | RRO | Black | H | No special | PO | | | | | | | | | | | | | | | | | | | | | | | | | | |
| ER | PG | 0.22 | 224 | ±10% | K | 6R3 | 6.3 | 4 | C | PCB Termial | | Green | L | Other trademark | WO | | | | | | | | | | | | | | | | | | | | | | | | | | |
| BR | VG | 0.33 | 334 | ±15% | L | 008 | 8 | 5 | D | Ammo Taping | | Violet | Z | Ø8 F=2.5mm | X0 | | | | | | | | | | | | | | | | | | | | | | | | | | |
| VT | VZ | 0.47 | 474 | ±20% | M | 010 | 10 | 6.3 | E | 2.0mm Pitch | T20 | Light purple | | | | | | | | | | | | | | | | | | | | | | | | | | | | | |
| SM | SX | 1 | 105 | ±30% | N | 016 | 16 | 8 | F | 2.5mm Pitch | T25 | Navy blue | S | | | | | | | | | | | | | | | | | | | | | | | | | | | | |
| KS | KF | 2.2 | 225 | -40% | W | 025 | 25 | 10 | G | 3.5mm Pitch | T35 | Sky blue | T | Finite height | GO | | | | | | | | | | | | | | | | | | | | | | | | | | |
| GM | KM | 3.3 | 335 | 0 | | 035 | 35 | 13 | J | 5.0mm Pitch | T50 | Coffee | | | | | | | | | | | | | | | | | | | | | | | | | | | | | |
| GS | EF | 4.7 | 475 | -20% | A | 050 | 50 | 16 | K | Lead Cut & Form | | Orange red | K | Special voltage | VX | | | | | | | | | | | | | | | | | | | | | | | | | | |
| ZF | GR | 10 | 106 | 0 | | 063 | 63 | 18 | L | C-Type | CXX | Transparent blue | M | Special capacitance | CX | | | | | | | | | | | | | | | | | | | | | | | | | | |
| LF | GF | 22 | 226 | -20% | C | 080 | 80 | 22 | N | E-Type | EXX | Transparent yellow | Y | | | | | | | | | | | | | | | | | | | | | | | | | | | | |
| EL | AL | 33 | 336 | 10% | | 100 | 100 | 25 | O | V-Type | VXX | Printing color | | | | | | | | | | | | | | | | | | | | | | | | | | | | | |
| KL | HL | 47 | 476 | -20% | X | 120 | 120 | 30 | P | Q-Type | QXX | Black | 1 | | | | | | | | | | | | | | | | | | | | | | | | | | | | |
| FL | GL | 100 | 107 | 40% | | 160 | 160 | 35 | Q | P-Type | PXX | White | 2 | | | | | | | | | | | | | | | | | | | | | | | | | | | | |
| ML | ZL | 220 | 227 | -10% | V | 200 | 200 | 40 | R | W-Type | WXX | Silvery | 3 | | | | | | | | | | | | | | | | | | | | | | | | | | | | |
| PL | RL | 330 | 337 | 20% | | 220 | 220 | 51 | S | K-Type | KXX | Golden | 4 | | | | | | | | | | | | | | | | | | | | | | | | | | | | |
| LM | LK | 470 | 477 | 0 | R | 250 | 250 | 63.5 | T | H-Type | HXX | | | | | | | | | | | | | | | | | | | | | | | | | | | | | | |
| LH | LL | 2200 | 228 | 20% | | 315 | 315 | 76 | U | Y-Type | YXX | | | | | | | | | | | | | | | | | | | | | | | | | | | | | | |
| NM | NS | 22000 | 229 | 0 | I | 350 | 350 | 90 | X | | | | | | | | | | | | | | | | | | | | | | | | | | | | | | | | |
| NP | NH | 33000 | 339 | 50% | | 400 | 400 | Len. (mm) | Code | | | | | | | | | | | | | | | | | | | | | | | | | | | | | | | | |
| BP | PZ | 47000 | 479 | | | 420 | 420 | 05 | 5 | | | | | | | | | | | | | | | | | | | | | | | | | | | | | | | | |
| MZ | FZ | 100000 | 10T | | | 450 | 450 | 07 | 7 | Sleeve Material | Code | | | | | | | | | | | | | | | | | | | | | | | | | | | | | | |
| LZ | PF | 150000 | 15T | | | 500 | 500 | 09 | 9 | PET | E | Rubber Shape | Code | | | | | | | | | | | | | | | | | | | | | | | | | | | | |
| AP | PE | 220000 | 22T | | | 550 | 550 | 10 | 10 | PVC | V | Plane | F | | | | | | | | | | | | | | | | | | | | | | | | | | | | |
| LS | LP | 330000 | 33T | | | | | | | | | Convex | T | | | | | | | | | | | | | | | | | | | | | | | | | | | | |
| FP | PN | 1000000 | 10M | | | | | | | | | Snap-in | S | | | | | | | | | | | | | | | | | | | | | | | | | | | | |
| MN | FN | 2200000 | 22M | | | | | | | | | V-chip | V | | | | | | | | | | | | | | | | | | | | | | | | | | | | |
| UN | | 3300000 | 33M | | | | | | | | | | | | | | | | | | | | | | | | | | | | | | | | | | | | | | |
| | | | | | | | | 12 | 12 | | | | | | | | | | | | | | | | | | | | | | | | | | | | | | | | |
| | | | | | | | | 13 | 13 | | | | | | | | | | | | | | | | | | | | | | | | | | | | | | | | |
| | | | | | | | | 14 | 14 | | | | | | | | | | | | | | | | | | | | | | | | | | | | | | | | |
| | | | | | | | | 15 | 15 | | | | | | | | | | | | | | | | | | | | | | | | | | | | | | | | |
| | | | | | | | | 16 | 16 | | | | | | | | | | | | | | | | | | | | | | | | | | | | | | | | |
| | | | | | | | | 17 | 17 | | | | | | | | | | | | | | | | | | | | | | | | | | | | | | | | |
| | | | | | | | | 20 | 20 | | | | | | | | | | | | | | | | | | | | | | | | | | | | | | | | |
| | | | | | | | | 21 | 21 | | | | | | | | | | | | | | | | | | | | | | | | | | | | | | | | |
| | | | | | | | | 25 | 25 | | | | | | | | | | | | | | | | | | | | | | | | | | | | | | | | |
| | | | | | | | | 30 | 30 | | | | | | | | | | | | | | | | | | | | | | | | | | | | | | | | |
| | | | | | | | | 35 | 35 | | | | | | | | | | | | | | | | | | | | | | | | | | | | | | | | |
| | | | | | | | | 40 | 40 | | | | | | | | | | | | | | | | | | | | | | | | | | | | | | | | |
| | | | | | | | | 45 | 45 | | | | | | | | | | | | | | | | | | | | | | | | | | | | | | | | |
| | | | | | | | | 50 | 50 | | | | | | | | | | | | | | | | | | | | | | | | | | | | | | | | |
| | | | | | | | | 55 | 55 | | | | | | | | | | | | | | | | | | | | | | | | | | | | | | | | |
| | | | | | | | | 60 | 60 | | | | | | | | | | | | | | | | | | | | | | | | | | | | | | | | |

GR Series

特性 FEATURES

- 105°C
- 寿命(Life time):2000~4000 Hours
- 高纹波(High ripple current)、低阻抗(Low Impedance)

主要技术性能 Specifications

| 项目 Item | 特性 Performance Characteristics | | | | | | | | | |
|---|--|--|--------|-----------------|----------|-------|-----------------|------|------|--|
| 使用温度范围 Operating Temperature Range | -40 ~ +105°C | | | | | | | | | |
| 额定电压范围 Rated Working Voltage Range | 6.3 ~ 100V | | | | | | | | | |
| 标称电容量范围 Nominal Capacitance Range | 2.2 ~ 4700μF | | | | | | | | | |
| 标称电容量允许偏差 Capacitance Tolerance | ±20%(120Hz,+20°C) | | | | | | | | | |
| 漏电流 Leakage Current | L≤0.01CV or 3(μA) 测试时间 2 分钟取最大值, 测试温度 20°C; Whichever is greater measured after 2 minutes application of rated working voltage at +20°C | | | | | | | | | |
| 损失角正切值 tan δ(120Hz,+20°C) | 工作电压(Voltage) | 6.3 | 10 | 16 | 25 | 35 | 50 | 63 | 100 | |
| | tan δ(max) | 0.22 | 0.19 | 0.16 | 0.14 | 0.12 | 0.10 | 0.09 | 0.08 | |
| 容量大于 1000μF, 每增加 1000μF 损耗值增加 0.02 For capacitance value>1000μF, app 0.02 per another 1000μF | | | | | | | | | | |
| 低温特性(120Hz) Low Temperature Characteristics | 工作电压(Voltage) | 6.3 | 10 | 16 | 25 | 35 | 50 | 63 | 100 | |
| | Z-25°C/Z+20°C | 4 | 3 | 2 | 2 | 2 | 2 | 2 | 2 | |
| | Z-40°C/Z+20°C | 8 | 6 | 4 | 3 | 3 | 3 | 3 | 3 | |
| 高温负荷 High Temperature Loading | 负荷寿命(Load Life) | 2000Hrs(D:5~6.3) | | 3000Hrs(D:8~10) | | | 4000Hrs(D≥12.5) | | | |
| | 试验条件(Test conditions) | 温度(Temp.) 105°C | | | | | | | | |
| | 容量变化率(Cap.) | 容量变化为初始值的±20% (Within ±20% of Initial Value) | | | | | | | | |
| | 损失角(tan δ) | 小于等于初始值 200% (200% or less of Initial Specified Value) | | | | | | | | |
| | 漏电流(LC) | 小于规格值 (Initial Specified Value or less) | | | | | | | | |
| 高温无负荷 Shelf Life | 无负荷寿命(Shelf life) | 1000 Hr□ | | | | | | | | |
| | 试验条件(Test conditions) | 温度(Temp.) 105°C | | | | | | | | |
| | 容量变化率(Cap.) | 容量变化为初始值的±20% (Within ±20% of Initial Value) | | | | | | | | |
| | 损失角(tan δ) | 小于等于初始值 200% (200% or less of Initial Specified Value) | | | | | | | | |
| | 漏电流(LC) | 小于规格值 (Initial Specified Value or less) | | | | | | | | |
| 纹波电流与频率修正系数 Ripple Current & Frequency Multipliers | Freq.(Hz) | | 50(60) | 120 | 1k | 10k | 100k | | | |
| | Cap.(μF) | | ~33 | 39~330 | 390~1000 | 1200~ | | | | |
| | | | 0.40 | 0.55 | 0.80 | 0.90 | 1.00 | | | |
| | | | 0.60 | 0.70 | 0.90 | 0.95 | 1.00 | | | |
| | | | 0.65 | 0.80 | 0.98 | 1.00 | 1.00 | | | |
| | | 0.80 | 0.90 | 0.98 | 1.00 | 1.00 | | | | |
| 参照标准 Standards | JIS- C-5101-4 (IEC 60384) | | | | | | | | | |

尺寸图(Diagram of Dimensions):

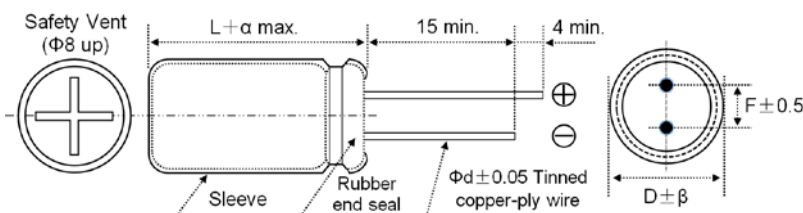

尺寸(Diameter):

单位(Unit):mm

| D | 5 | 6.3 | 8(L<20) | 8(L≥20) | 10 | 13 |
|---|-----------|-----|---------|-----------|-----|-----|
| F | 2.0 | 2.5 | 3.5 | | 5.0 | |
| d | 0.5 | | 0.5 | 0.6 | 0.6 | 0.6 |
| α | (L<20)1.5 | | | (L≥20)2.0 | | |
| β | (D<20)0.5 | | | (D≥20)1.0 | | |

标准额定值(Standard Rating) :

D x L(mm): Ripple Current: mA/rms at 100kHz,105℃

| Voltage(Code) | 6.3V | | | 10V | | | 16V | | |
|---------------|----------|-------|------|--------|-------|------|--------|-------|------|
| | Cap.(μF) | DxL | IMP | R.C | DxL | IMP | R.C | DxL | IMP |
| 100 | 5*11 | 0.580 | 140 | 5*11 | 0.58 | 140 | 6.3*12 | 0.250 | 300 |
| 120 | 5*11 | 0.530 | 165 | 5*11 | 0.53 | 140 | 6.3*12 | 0.250 | 320 |
| 150 | 6.3*12 | 0.250 | 185 | 6.3*12 | 0.25 | 340 | 6.3*12 | 0.220 | 340 |
| | | | | | | | 8*12 | 0.150 | 500 |
| 180 | 6.3*12 | 0.250 | 255 | 6.3*12 | 0.250 | 340 | 6.3*12 | 0.220 | 340 |
| | | | | | | | 8*12 | 0.150 | 580 |
| 220 | 6.3*12 | 0.250 | 275 | 6.3*12 | 0.220 | 340 | 6.3*12 | 0.220 | 340 |
| | | | | | | | 8*12 | 0.150 | 600 |
| 270 | 6.3*12 | 0.220 | 280 | 6.3*12 | 0.220 | 340 | 8*12 | 0.150 | 640 |
| | | | | 8*12 | 0.130 | 580 | | | |
| 330 | 6.3*12 | 0.220 | 340 | 6.3*12 | 0.220 | 340 | 8*12 | 0.130 | 640 |
| | 8*12 | 0.130 | 580 | 8*12 | 0.130 | 640 | | | |
| 390 | 8*12 | 0.130 | 600 | 8*12 | 0.130 | 640 | 8*12 | 0.130 | 640 |
| 470 | 8*12 | 0.130 | 640 | 8*12 | 0.130 | 640 | 8*12 | 0.130 | 640 |
| | | | | | | | 10*13 | 0.100 | 865 |
| 560 | 8*12 | 0.130 | 640 | 8*12 | 0.130 | 640 | 10*13 | 0.100 | 880 |
| 680 | 8*12 | 0.130 | 640 | 8*12 | 0.130 | 640 | 8*16 | 0.087 | 750 |
| | | | | | | | 10*13 | 0.087 | 865 |
| 820 | 8*12 | 0.130 | 640 | 10*13 | 0.080 | 865 | 10*17 | 0.075 | 1210 |
| | 10*13 | 0.110 | 865 | | | | | | |
| 1000 | 8*12 | 0.130 | 640 | 8*16 | 0.087 | 760 | 10*17 | 0.075 | 1210 |
| | 10*13 | 0.087 | 865 | 10*17 | 0.075 | 1210 | | | |
| 1200 | 8*16 | 0.096 | 840 | 10*20 | 0.060 | 1400 | 10*20 | 0.060 | 1400 |
| | 10*13 | 0.087 | 880 | | | | | | |
| 1500 | 8*20 | 0.069 | 1050 | 10*20 | 0.060 | 1430 | 10*20 | 0.060 | 1430 |
| | 10*17 | 0.069 | 1210 | | | | | | |
| 1800 | 10*20 | 0.060 | 1400 | 10*20 | 0.060 | 1460 | 10*25 | 0.052 | 1650 |
| | | | | | | | 13*20 | 0.046 | 1900 |
| 2200 | 10*20 | 0.060 | 1460 | 10*20 | 0.060 | 1490 | 13*20 | 0.045 | 1920 |
| 2700 | 10*25 | 0.050 | 1650 | 10*25 | 0.050 | 1650 | 13*25 | 0.040 | 2124 |
| | 13*20 | 0.050 | 1650 | 13*20 | 0.035 | 1900 | | | |
| 3300 | 10*25 | 0.050 | 1650 | 13*25 | 0.030 | 2124 | | | |
| | 13*20 | 0.050 | 1870 | | | | | | |
| 3900 | 13*20 | 0.046 | 1900 | | | | | | |
| 4700 | 13*25 | 0.046 | 2124 | | | | | | |

* 13mm may be replaced by 12.5mm upon customer's request.

标准额定值(Standard Rating) :

D x L(mm): Ripple Current: mA/rms at 100kHz,105℃

| Voltage(Code) | 25V | | | 35V | | | 50V | | |
|---------------|----------|-------|------|--------|-------|------|--------|-------|------|
| | Cap.(μF) | DxL | IMP | R.C | DxL | IMP | R.C | DxL | IMP |
| 33 | | | | | | | 6.3*12 | 0.500 | 230 |
| 39 | | | | | | | 6.3*12 | 0.500 | 265 |
| 47 | | | | 6.3*12 | 0.250 | 300 | 6.3*12 | 0.500 | 295 |
| 56 | | | | 6.3*12 | 0.250 | 315 | 8*12 | 0.420 | 515 |
| 68 | | | | 6.3*12 | 0.240 | 340 | 8*12 | 0.420 | 535 |
| 82 | 6.3*12 | 0.220 | 320 | 8*12 | 0.230 | 625 | 8*12 | 0.420 | 555 |
| 100 | 6.3*12 | 0.220 | 340 | 8*12 | 0.220 | 640 | 10*13 | 0.200 | 760 |
| 120 | 8*12 | 0.200 | 565 | 8*12 | 0.200 | 655 | 8*16 | 0.200 | 730 |
| | | | | | | | 10*13 | 0.200 | 780 |
| 150 | 8*12 | 0.180 | 580 | 8*12 | 0.180 | 670 | 10*17 | 0.130 | 825 |
| 180 | 8*12 | 0.150 | 600 | 10*13 | 0.130 | 760 | 8*20 | 0.130 | 825 |
| | | | | | | | 10*17 | 0.130 | 855 |
| 220 | 8*12 | 0.130 | 620 | 8*12 | 0.130 | 640 | 10*17 | 0.130 | 875 |
| | | | | 8*16 | 0.100 | 830 | | | |
| | | | | 10*13 | 0.100 | 830 | | | |
| 270 | 8*12 | 0.130 | 640 | 10*17 | 0.075 | 1210 | 10*25 | 0.093 | 1025 |
| | 10*13 | 0.100 | 825 | | | | | | |
| 330 | 8*12 | 0.130 | 665 | 8*20 | 0.087 | 1050 | 13*20 | 0.090 | 1660 |
| | 10*13 | 0.100 | 845 | 10*17 | 0.075 | 865 | | | |
| | 10*13 | 0.100 | 845 | 10*17 | 0.075 | 1210 | | | |
| 390 | 10*13 | 0.100 | 865 | 10*17 | 0.075 | 1210 | 13*20 | 0.090 | 1680 |
| 470 | 8*16 | 0.087 | 840 | 10*17 | 0.075 | 1210 | 13*25 | 0.088 | 1950 |
| | 10*13 | 0.100 | 885 | | | | | | |
| 560 | 10*17 | 0.075 | 1210 | 10*20 | 0.060 | 1380 | 13*25 | 0.088 | 1970 |
| 680 | 10*17 | 0.075 | 1210 | 10*20 | 0.058 | 1400 | | | |
| 820 | 10*20 | 0.060 | 1370 | 10*25 | 0.054 | 1650 | | | |
| | | | | 13*20 | 0.046 | 1900 | | | |
| 1000 | 10*20 | 0.058 | 1400 | 13*20 | 0.046 | 1920 | | | |
| | | | | 13*25 | 0.042 | 2124 | | | |
| 1200 | 10*20 | 0.055 | 1420 | | | | | | |
| 1500 | 10*25 | 0.050 | 1650 | | | | | | |
| | 13*20 | 0.047 | 1900 | | | | | | |
| 1800 | 13*25 | 0.043 | 2104 | | | | | | |
| 2200 | 13*25 | 0.040 | 2124 | | | | | | |

| Voltage(Code) | 63V | | | 100V | | |
|---------------|----------|-------|-----|--------|-------|-----|
| | Cap.(μF) | DxL | IMP | R.C | DxL | IMP |
| 15 | | | | 6.3*12 | 1.880 | 115 |
| 22 | 6.3*12 | 1.050 | 115 | 8*12 | 1.530 | 230 |
| 27 | 6.3*12 | 1.050 | 120 | 8*12 | 1.320 | 232 |
| 33 | 6.3*12 | 1.050 | 125 | 8*12 | 1.280 | 330 |
| 39 | 8*12 | 0.800 | 200 | 8*16 | 0.980 | 300 |
| 47 | 8*12 | 0.780 | 212 | 10*13 | 0.650 | 370 |
| 56 | 8*12 | 0.760 | 222 | 8*20 | 0.480 | 362 |
| 68 | 8*12 | 0.750 | 234 | 10*17 | 0.460 | 357 |
| 82 | 10*13 | 0.700 | 314 | 10*20 | 0.430 | 466 |
| 100 | 8*16 | 0.630 | 300 | 10*20 | 0.430 | 466 |
| | 10*13 | 0.580 | 314 | | | |
| 120 | 10*17 | 0.324 | 357 | 13*20 | 0.368 | 690 |
| 150 | 8*20 | 0.324 | 362 | 13*20 | 0.357 | 760 |
| 180 | 10*20 | 0.190 | 466 | 13*25 | 0.328 | 922 |
| 220 | 10*20 | 0.190 | 466 | 13*25 | 0.328 | 880 |
| 270 | 13*20 | 0.128 | 670 | | | |
| 330 | 13*20 | 0.128 | 690 | | | |
| 390 | 13*25 | 0.118 | 922 | | | |

* 13mm may be replaced by 12.5mm upon customer's request.

 本产品目录中规格如有变更恕不另行通知
 Specifications are subject to change without notice.

1. Scope 适用范围:

This specification applies to aluminum electrolytic capacitor , used in electronic equipment .

本说明适用于用电子仪器设备进行检测之铝电解电容器.

2. Electrical characteristics 电气特性:

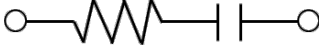
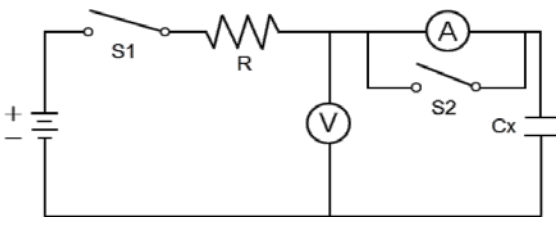
| NO. | ITEM 项目 | TEST METHOD 测试方法 | SPECIFICATION 规格 | | | | | | | | | | | | | | | |
|---------|--------------------------------------|---|---|-------------------|------------------------|---|-------|----|---|------------|-----|---|-------|----|---|---------|-----|---|
| 2.1 | Rated voltage 额定电压 | | | | | | | | | | | | | | | | | |
| 2.2 | Capacitance 静电容量 | 1.Measuring frequency :120 ±12Hz 测试频率 | Voltage range 、Capacitance range, see specification of this series. 电压、容量范围请看该系列之规格说明. | | | | | | | | | | | | | | | |
| 2.3 | Dissipation factor 散逸因素 (损失角) | 2.Measuring voltage : ≤0.5Vrms + 0.5~2.0VDC 测试电压 3.Measurement circuit :  测试电路 | | | | | | | | | | | | | | | | |
| 2.4 | Leakage current 泄漏电流 | DC Leakage current shall be measured after 1~2 minutes application of the DC rated working voltage through the 1000 Ω resistor at 20℃. 在20℃通过1000Ω的电阻施加直流工作电压1~2分钟后测定直流泄漏电流.  R :1000 ±100Ω S1 :Swich 开关 A :DC Current meter S2 :Swich for protect of 直流电流计 Current meter V :DC Voltage meter 直流电流计的保护开关 直流电压计 CX :Testing Capacitor 测试电容 | Dissipation factor 、Leakage current, see specification of this series. 损失角、泄漏电流请看该系列之规格说明. | | | | | | | | | | | | | | | |
| 2.5 | Temperature characteristics 高低温特性 | <table border="1"> <thead> <tr> <th>STEP 步骤</th> <th>TEMPERATURE 温度(℃)</th> <th>STORAGE TIME 放置时间(min)</th> </tr> </thead> <tbody> <tr> <td>1</td> <td>20 ±2</td> <td>30</td> </tr> <tr> <td>2</td> <td>下限温度(0/-3)</td> <td>120</td> </tr> <tr> <td>3</td> <td>20 ±2</td> <td>15</td> </tr> <tr> <td>4</td> <td>上限温度 ±2</td> <td>120</td> </tr> </tbody> </table> <p>Step 1. Measure the capacitance and impedance. 测试静电容量及阻抗($Z_{20℃}$) . (Z ,120Hz ±10%)</p> <p>Step 2. Measure the impedance at thermal balance after 2 hours. 达到热平衡2小时后测试阻抗(Z_r) . (Z ,120Hz ±10%)</p> <p>Step 4. Measure the capacitance and leakage current at thermal balance after 2 hours. 达到热平衡2小时后测试静电容量及漏电流 .</p> | STEP 步骤 | TEMPERATURE 温度(℃) | STORAGE TIME 放置时间(min) | 1 | 20 ±2 | 30 | 2 | 下限温度(0/-3) | 120 | 3 | 20 ±2 | 15 | 4 | 上限温度 ±2 | 120 | <p>Step 2. Impedance ratio ($Z_r/Z_{20℃}$) less than specified value. 阻抗比 :低于规定值 .</p> <p>Step 4 Capacitance change : within ± 20% of the initial measured value. 容量变化 : 初测值的±20%以内.</p> <p>Leakage current : Under 125 °C for 10 times specification values,105 °C for 8 times the specification values, 85 °C for 5 times the specification values 泄漏电漏: 125℃為規格值10倍以下, 105℃為為規格值8倍以下, 85℃為規格值5倍以下</p> |
| STEP 步骤 | TEMPERATURE 温度(℃) | STORAGE TIME 放置时间(min) | | | | | | | | | | | | | | | | |
| 1 | 20 ±2 | 30 | | | | | | | | | | | | | | | | |
| 2 | 下限温度(0/-3) | 120 | | | | | | | | | | | | | | | | |
| 3 | 20 ±2 | 15 | | | | | | | | | | | | | | | | |
| 4 | 上限温度 ±2 | 120 | | | | | | | | | | | | | | | | |

| No. | ITEM 项目 | TEST METHOD 测试方法 | SPECIFICATION 规格 |
|-----|---|--|--|
| 2.6 | Surge test 浪涌(突波)试验 | Rated surge voltage shall be applied (swich on) for 30±5 seconds and then shall be applied (swich off) with discharge for 5±0.5 min at room temperature .This cycle shall be repeated for 1000 cycles .Duration of one cycle is 6±0.5 minutes . 在常温下施加(合上开关)额定涌浪电压30±5秒,然后停止施加(断开开关)涌浪电压并且放电5±0.5分钟.这个循环要重复1000次.以 6±0.5分钟为一个循环周期. | Capacitance change : Within ± 15% of the initial measured value. 容量变化: 初测值的 ±15%以内. Dissipation factor: Within initial specified value. 损失角:规定值以内. Leakage current: Within initial specified value. 泄漏电流:规定值以内. |
| 2.7 | MAXIMUM APPLICABLE RIPPLE CURRENT 高温纹波负荷试验 | The maximum A.C.current having frequency of 120Hz (or 100KHz) The capacitors shall applide with rated DC voltage and maximum ripple current at Max. temperature ±2℃ for X load life time.(The sum of the DC voltage plus the AC ripple voltage must not exceed the rated DC voltage) 在120Hz(or 100KHz)频率条件下,在额定最高温度壽命X小時下.電容器施加額定DC電壓與最大紋波電流.(DC電壓疊加AC紋波電壓,不得超過DC額定電壓) (X : see specification of this series. 見該系列規格說明 .) | Standard of judgement is according to requirement of this series. 判定标准依该系列要求 . |

3.Mechanical characteristics 机械特性:

| No. | ITEM 项目 | TEST METHOD 测试方法 | SPECIFICATION 规格 | | | | | | | | | | | | | | | | | | | | |
|------------|-----------------------|--|------------------|------------|-----------|------------|------------|------|-----|-----|--------|-----------------------|-----------|-----|-------|------------|-----------|------------|------------|------|------|-----|---|
| 3.1 | Lead strength 端子强度 | <p>(A).Tensile strength 拉伸强度:</p> <p>1).wire lead terminal 导针型 :</p> <table border="1"> <tr> <td>d(mm)</td> <td>0.35<d≤0.5</td> <td>0.5<d≤0.8</td> <td>0.8<d≤1.25</td> </tr> <tr> <td>Load (Kgf)</td> <td>0.51</td> <td>1.0</td> <td>2.0</td> </tr> </table> <p>2).snap-in terminal 尖脚型 :</p> <table border="1"> <tr> <td>d (mm)</td> <td>snap-in terminal 尖脚端子</td> </tr> <tr> <td>load (Kg)</td> <td>2.0</td> </tr> </table> <p>The capacitor terminals to bear the load 10 seconds of the above-mentioned provisions, there can be no electrical or mechanical properties on the damage. 电容器各端子要承受上表规定的荷重10秒,不能有电气或机械特性上的损伤.</p> <p>(B).Bending strength 弯曲强度:</p> <p>wire lead terminal 导针型 :</p> <table border="1"> <tr> <td>d(mm)</td> <td>0.35<d≤0.5</td> <td>0.5<d≤0.8</td> <td>0.8<d≤1.25</td> </tr> <tr> <td>Load (Kgf)</td> <td>0.25</td> <td>0.51</td> <td>1.0</td> </tr> </table> <p>Will test capacitance vertical fixed, applying the above-mentioned provisions to each terminal axial load, slowly turn capacitor by the vertical position to horizontal position, then rotate 180 ° in the opposite direction, back to the initial vertical position (about 5 s) the whole process.The capacitor performance cannot change and loss of the terminal can't have. 将测试电容垂直固定,给每一端子轴向施加上表规定荷重后,慢慢将电容器由竖直位置转至水平位置,然后反方向旋转180°后,再回到初始的垂直位置(整个过程约5S). 电容器性能不能有变化及端子不能有损伤.</p> | d(mm) | 0.35<d≤0.5 | 0.5<d≤0.8 | 0.8<d≤1.25 | Load (Kgf) | 0.51 | 1.0 | 2.0 | d (mm) | snap-in terminal 尖脚端子 | load (Kg) | 2.0 | d(mm) | 0.35<d≤0.5 | 0.5<d≤0.8 | 0.8<d≤1.25 | Load (Kgf) | 0.25 | 0.51 | 1.0 | <p>When the capacitance is measured, there shall be no intermittent contacts,or open or short circuiting. 测试静电容量时,不能有接触不良,开路或短路。</p> <p>There shall be no such mechanical damage as terminal damage etc. 不能有如端子受损之类的机械特性上的损伤。</p> |
| d(mm) | 0.35<d≤0.5 | 0.5<d≤0.8 | 0.8<d≤1.25 | | | | | | | | | | | | | | | | | | | | |
| Load (Kgf) | 0.51 | 1.0 | 2.0 | | | | | | | | | | | | | | | | | | | | |
| d (mm) | snap-in terminal 尖脚端子 | | | | | | | | | | | | | | | | | | | | | | |
| load (Kg) | 2.0 | | | | | | | | | | | | | | | | | | | | | | |
| d(mm) | 0.35<d≤0.5 | 0.5<d≤0.8 | 0.8<d≤1.25 | | | | | | | | | | | | | | | | | | | | |
| Load (Kgf) | 0.25 | 0.51 | 1.0 | | | | | | | | | | | | | | | | | | | | |

| No. | ITEM 项目 | TEST METHOD 测试方法 | SPECIFICATION 规格 |
|-----|----------------------------|--|---|
| 3.2 | Vibration resistance 振动 | Vibration frequency to evenly, cover a wide range of 10 Hz ~ 55 Hz, amplitude is 1.5 mm, in 1 minute to complete the cycle. The capacitor by terminal firmly fixed. The capacitors should be in three mutually perpendicular direction vibration, vibration for 2 hours in each direction. 振动频率要均匀,范围为10Hz~55 Hz,振幅为1.5mm,在1分钟内完成该循环. 电容器由端子牢固地固定. 电容器应在三个互相垂直的方向振动,每个方向振动 2 小时 . | Capacitance :no unsteady. 静电容量:稳定. Appearance: no abnormal. 外观:无异常 . Capacitance change : Within $\pm 5\%$ of the initial measured value. 容量变化:初测值的 $\pm 5\%$ 以内. Dissipation factor: Within initial specified value. 损失角:规定值以内. Leakage current: Within initial specified value. 泄漏电流:规定值以内. |
| 3.3 | Solderability 可焊性 | The leads are dipped in the solder bath of Sn at 235 ± 5 °C for 2 ± 0.5 seconds . The dipping depth should be set at 1.5 ~ 2.0 mm. 端子浸没在 245 ± 5 °C的锡焊液中 2 ± 0.5 秒,浸没深度设定为1.5~2.0mm . | The solder alloy shall cover the 90% or more of the dipped lead's area . 锡液要覆盖导针浸入表面积90%以上 . |

4. Reliability 信赖性:



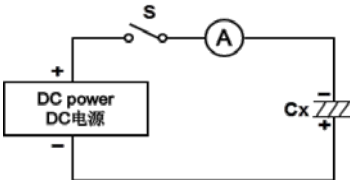

| No. | ITEM 项目 | TEST METHOD 测试方法 | SPECIFICATION 规格 |
|-----|------------------------------------|---|--|
| 4.1 | Soldering heat resistance 耐焊接热 | The leads immerse in the solder bath of Sn at 260 ± 5 °C for 10 ± 1 seconds until a distance of 1.5 ~ 2mm from the case . 导针在 260 ± 5 °C 的锡 焊液中浸没至离本体 1.5 ~ 2 mm 的地方 10 ± 1 秒鐘 . | No damage or leakage of electrolyte. 无损伤或电解液漏出. Capacitance change : Within $\pm 5\%$ of the initial measured value. 容量变化:初测值的 $\pm 5\%$ 以内. Dissipation factor: Within initial specified value. 损失角:规定值以内. Leakage current: Within initial specified value. 泄漏电流:规定值以内. |
| 4.2 | Damp heat (steady state) 稳态湿热 | Subject the capacitors to 40 ± 2 °C and 90% to 95% relative humidity for 500+24/0 hours 电容器在 40 ± 2 °C及相对湿度90%到95%的条件下贮存500(-0~+24)小时. | Capacitance change : Within $\pm 10\%$ of the initial measured value. 容量变化:初测值的 $\pm 10\%$ 以内. Dissipation factor: less than 120% of the initial specified 损失角:低于规定值的120% . Leakage current: Within initial specified value. 泄漏电流:规定值以内. |

| NO. | ITEM 项目 | TEST METHOD 测试方法 | SPECIFICATION 规格 |
|-----|------------------------------------|--|--|
| 4.3 | Load life 高温负荷 | <p>After X hours continuous application of DC rated working voltage at Max. temperature $\pm 5^{\circ}\text{C}$. Measurements shall be performed after 8 hours exposed at room temperature . 在最高使用温度$\pm 5^{\circ}\text{C}$环境下,连续施加额定的DC工作电压 X 小时. 室温暴露8小时以上进行测试.</p> <p>(X:see specification of this series.见该系列规格说明.)</p> | <p>Standard of judgement is according to requirement of this series. 判定标准依该系列要求 .</p> |
| 4.4 | Shelf life 高温储存 | <p>After storage for Y hours at temperature $\pm 5^{\circ}\text{C}$ (See specification of this series) without voltage application, the measurements shall meet the following limits . Measurements shall be performed after exposed for 8 hrs at room temperature after application of DC rated voltage to the capacitor for Z minutes . 在目录书规定的温度环境中,不施加电压放置 Y 小时后按以下条件测试. 室温暴露8 小时以上,施加DC额定电压 Z 分钟后进行。</p> <p>(Y,Z :See specification of this series.见该系列规格说明)</p> | |
| 4.5 | Storage at low temperature 低温储存 | <p>The capacitor shall be stored at $-40\pm 3^{\circ}\text{C}$ temperature for 16 hours ,during which time no voltage shall be applied.And then the capacitor shall be subjected to standard atmospheric conditions for 16 hours or more ,after which measurements shall be made . 电容器在$-40\pm 3^{\circ}\text{C}$ 环境当中贮存16小时,其间不施加电压;之后,在标准大气压中露置16小时以上,然后进行测试.</p> | <p>Capacitance change : Within $\pm 10\%$ of the initial measured value. 容量变化:初测值$\pm 10\%$以内. Dissipation factor: Within initial specified value. 损失角:规定值以内. Leakage current: Within initial specified value. 泄漏电流:规定值以内. Appearance :no abnormal. 外观: 无异常.</p> |

| NO. | ITEM 项目 | TEST METHOD 测试方法 | SPECIFICATION 规格 |
|-----|--------------------|---|--|
| 4.6 | Pressure relief 防爆 | <p>Reverse the following rules are applied electric current of DC working voltage 反向施加以下电流的DC工作电压.</p> <p>Where case size 外壳尺寸 (D 直径) : $D \leq 22.4\text{mm}$: 1 A max. $D > 22.4\text{mm}$: 10 A max.</p> <p>Note 注意:</p> <p>1.This requirement applies to capacitors with a diameter of 8 mm or more . 此要求适用于直径8mm或以上之电容器.</p> <p>2. When the pressure relief dvice does not open even 30 minutes after commencement of test ,the test may be ended . 测试30分钟后防爆装置仍不动作的,试验终止.</p> <p>3.The pressure relief dvice shall open in such a way as to avoid any dange of fire or explosion of capacitor elements (terminal and metal foil etc) or cover . 防爆装置必须动作,以防止发生火灾、爆炸或金属片飞溅.</p> | <p>DC test circuit 直流测试电路</p>  <p>S :Switch 开关 A :DC current meter DC电流表 Cx :Testing capacitor 测试电容</p> |

5. 外观Marking :

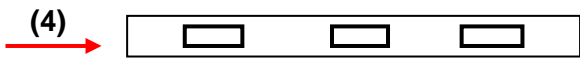
产品外套管印刷内容如下

| 序号 | 项目内容说明 | 图示 |
|-----|-------------|--|
| (1) | 商标 |  |
| (2) | 标称静电容量 |  |
| (3) | 额定工作电压 |  |
| (4) | 负极线标示 |  |
| (5) | 系列和温度 |  |
| (6) | 年份+周期(套管材质) | |

6.包装数量标准:

| 产品外形尺寸 D×L (mm) | 小袋数量 (只/袋) | 散装/切脚 (袋/内箱) | 散装/切脚内箱 (KPCS) | 散装/切脚大箱 (KPCS) (KPCS) | 备注 |
|--------------------|---------------|-----------------|-------------------|----------------------------|----|
| φ3*5 | 2000+3 | 25 | 50 | 100 | |
| φ4*5-7、φ5*5 | 1000+2 | 50 | 50 | 100 | |
| φ6.3*5、φ5*7 | 1000+2 | 30 | 30 | 60 | |
| φ6.3*7、φ5*11/12 | 1000+2 | 25 | 25 | 50 | |
| φ6.3*11、φ8*5 | 1000+1 | 20 | 20 | 40 | |
| φ6.3*12 | 1000+1 | 16 | 16 | 32 | |
| φ8*7 | 1000+1 | 18 | 18 | 36 | |
| φ8*9 | 500+1 | 30 | 15 | 30 | |
| φ8*11/12 | 500+1 | 25/25 | 12.5/12.5 | 25/25 | |
| φ8*14 | 500+1 | 20 | 10 | 20 | |
| φ8*16-20 | 500+1 | 16 | 8 | 16 | |
| φ10*13 | 500+1 | 15 | 7.5 | 15 | |
| φ10*15 | 400 | 15 | 6 | 12 | |
| φ10*17-20 | 200 | 25 | 5 | 10 | |
| φ10*25 | 200 | 20 | 4 | 8 | |
| φ10*30 | 100 | 30 | 3 | 6 | |
| φ13*17-21 | 200 | 15 | 3 | 6 | |
| φ13*25 | 200 | 12 | 2.4 | 4.8 | |
| φ13*30 | 100 | 20 | 2 | 4 | |
| φ16*18-22 | 100 | 20 | 2 | 4 | |
| φ16*25 | 100 | 15 | 1.5 | 3 | |
| φ16*30 | 100 | 12 | 1.2 | 2.4 | |
| φ16*35 | 50 | 20 | 1 | 2 | |
| φ18*27 | 100 | 10 | 1 | 2 | |
| φ18*30 | 50 | 15 | 0.75 | 1.5 | |
| φ18*36 | 50 | 15 | 0.75 | 1.5 | |
| φ18*40 | 50 | 10 | 0.5 | 1.5 | |
| φ18*50 | 25 | 15 | 0.375 | 0.75 | |
| φ22*30 | 50 | 10 | 0.5 | 1 | |
| φ22*35 | 50 | 10 | 0.5 | 1 | |
| φ22*40 | 50 | 10 | 0.5 | 1 | |
| φ25*25 | 50 | 10 | 0.5 | 1 | |
| φ25*30 | 50 | 10 | 0.5 | 1 | |

备注: 包装外箱L480mm*W320mm*H320mm
内箱L300mm*W230mm*H300mm

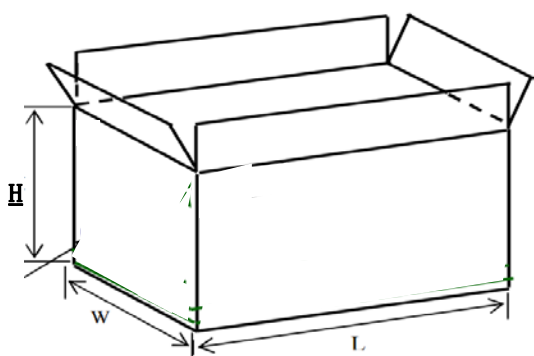

外箱

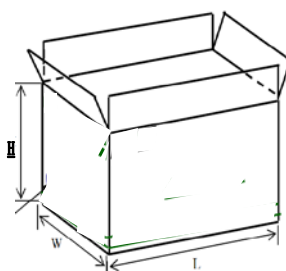

内箱