

安規陶瓷電容器產品承認書

APPROVAL SPECIFICATIONS FOR SAFETY RECOGNIED CERAMIC CAPACITORS

客戶 CUSTOMER			
客戶料號 CUSTOMER P/N			
產品編碼 PART NUMBER	Y1332M-E1I-F4-AC400V		
規格描述 DESCRIPTION	Y1/332/M/F10/L24/Y5V/ZNRC/400V~		
日期 DATE	2022-07-05	文件編號 DOC. NO.	DEC-WD-WI001(C)

德爾創承認欄 APPROVED BY DERSONIC			客戶承認欄 APPROVED BY CUSTOMER	
批 準 APPROVED BY	審 核 CHECK BY	制 訂 FORMULATE BY	批 準 APPROVED BY	審 核 CHECK BY
彭少雄	吳成愛 承認專用章	陳冬花		

東莞市德爾創電子有限公司

DONGGUAN CITY DERSONIC ELECTRONICS CO., LTD.

廣東省東莞市長安鎮錦廈河南工業區錦平路 5 號

NO.5, JINGPING ROAD, JINXIA HENAN INDUSTRIAL ZONE, CHANGAN TOWN DONGGUAN CITY, PRC

TEL: 86-769-8155 5686

FAX: 86-0769-8155 5989

WEBSITE: [HTTP://WWW.DERSONIC.COM](http://www.dersonic.com)

E-MAIL: SALES@DERSONIC.COM

目录 CONTENTS	数据表 DATA SHEET	2
	特点 FEATURES	3
	用途 APPLICATIONS	3
	规格清单 SPECIFICATIONS LIST	4
	标准与试验方法 SPECIFICATIONS AND TESTING METHODS	5
	标志 MARKING	7
	包装 PACKAGING	8
	编带规格 TAPING SPECIFICATIONS	9
	测量和使用注意事项 MEASURING AND APPLICATION NOTICE	10
	贮存条件 STORAGE ENVIRONMENT	13
	焊锡和安装 SOLDERING AND MOUNTING	14



請確保我們的產品安裝到您的產品上前，已根據您的需求進行了評估。

Please make sure that your product has been evaluated in view of your specifications with our product being mounted to your product.

請您在使用我們的產品時，不要偏離此標準。

You are requested not to use our product deviating from this specification.

数据表
DATA SHEET

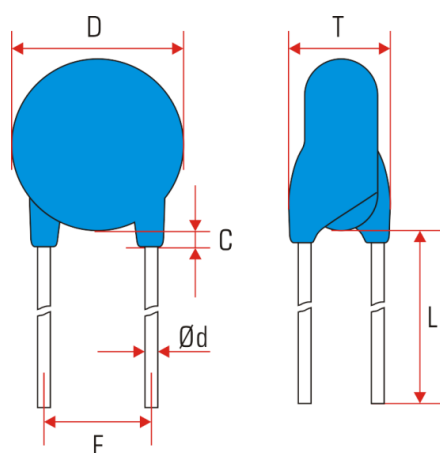

产品编码 Part number	Y1332M-E11-F4-AC400V	
规格描述 Description	Y1/332/M/F10/L24/Y5V/ZNRC/400V~	
客户料号 Customer P/N		
认证型号 Type	CD	
安规类别 Safety subclass	Y1	
工作温度范围 Operating temperature range	-40°C ~ +125°C	
额定电压 Rated voltage	400V~	
电容量 Capacitance	3300pF ±20% @ 1kHz 1.0V 25°C	
损耗角正切 Tangent of loss angle	0.025 max @ 1kHz 1.0V 25°C	
耐电压 Testing voltage	4000VAC (Charge/discharge 50mA max), 60s, PASS	
绝缘电阻 Insulation resistance	10 000MΩ min @ 500V 60s	
温度特性 Temperature characteristics	Y5V	
气候类别 Climatic category	40/125/21	
阻燃等级 Passive flammability category	C	
尺寸 DIMENSIONS	D (Diameter)	6.2mm ±1.0mm
	T (Thickness)	3.4mm ±0.8mm
	F (Lead spacing)	10mm ±1.0mm
	L (Lead length)	24mm ±4.0mm
	Ød (Lead diameter)	0.60mm ±0.10mm
	C (Coating rundown on lead)	3mm max

安规陶瓷电容器

SAFETY RECOGNIZED CERAMIC CAPACITORS



— 德信立業 創新開拓 —

特点 FEATURES

- 符合IEC 60384-14标准要求，通过UL/cUL、VDE、ENEC和CQC安规认证
Complies with IEC 60384-14 standard, through UL/cUL, VDE, ENEC and CQC certification
- 操作温度高达125°C
Operating temperature guaranteed up to 125 degrees
- 可承受波形为1.2/50μs、峰值电压为8kV(Y2: 5kV)的脉冲电压冲击
Can withstand waveform 1.2/50μs, peak voltage of 8kV (Y2: 5kV) surge impulse
- 采用UL94 V-0级环氧树脂包封
Coated with flame-retardant epoxy resin conforming to UL94 V-0 standard
- 可适用于自动化生产线
Cost-saving automatic insertion available
- 符合RoHS 2.0标准，无卤
Comply with RoHS 2.0, Halogen-free available



- 基本电性能
General electric performance

类别 Subclass	Y1 (CD)	Y2 (CS)
容量 Capacitance (C _n)	10pF ~ 0.0047μF	10pF ~ 0.01μF
额定电压 Rated Voltage	250Vac, 400Vac, 500Vac	
耐电压 Withstand voltage	4000Vac测量1分钟，无异常 The capacitor should not be damaged when apply 4000Vac measured for 1 minute.	2500Vac测量1分钟，无异常 The capacitor should not be damaged when apply 2500Vac measured for 1 minute.
损耗角正切 Tangent of loss angle	0.025 max	
绝缘电阻 Insulation resistance	大于10 000MΩ，使用500VDC测量1分钟 10 000MΩ minimum at 500VDC for 1 minute.	
温度特性 Temperature characteristic	Y5P, Y5U, Y5V	
气候类别 Climatic category	40/125/21	
阻燃等级 Passive flammability category	C	

- 安规认证
Safety approval

认证标志 Approval mark	认证标准 Approval standards	额定电压 Rated voltage	证书编号 Certificate number
	UL 60384-14	250Vac 400Vac 500Vac	E472525
	DIN EN 60384-14(VDE 0565-1-1):2014-04 EN 60384-14:2013-08 IEC 60384-14(ed. 4)		Y1: 40040706 Y2: 40045478
	IEC 60384-14:2013		Y1: CQC15001123983 Y2: CQC17001162592

用途 APPLICATIONS

- 用作交流线路滤波器以及开关电源和交流转接器初级一次级耦合的X/Y等级电容器。
Ideal for use as X/Y capacitors for AC line filter and primary-secondary coupling on switching power supplies and AC adapters.
- 无变压器DAA调制解调器的D-A绝缘和降噪。
Ideal for use on D-A isolation and noise absorption for DAA modems without transformers.

安规陶瓷电容器 SAFETY RECOGNIZED CERAMIC CAPACITORS



— 德信立業 創新開拓 —

规格清单 SPECIFICATIONS LIST

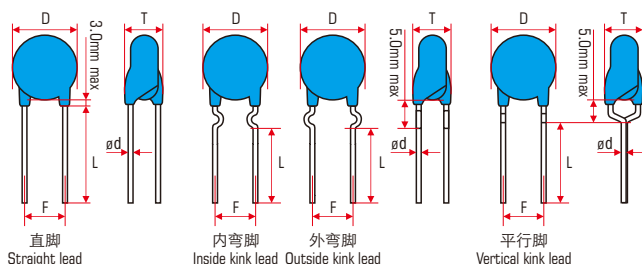

本体颜色: 蓝色
Body color: sky-blue
封装层: 环氧树脂 (UL94 V-0)
Coating: epoxy resin (UL94 V-0)
导线: CP线
Lead wire: CP wire

类别 Subclass	Y2			Y1		
额定电压 Rated voltage	250 / 300 / 400 / 500Vac			250 / 400 / 500Vac		
温度特性 Temperature characteristic	Y5P (B4)	Y5U (E4)	Y5V (F4)	Y5P (B4)	Y5U (E4)	Y5V (F4)
容量 (pF) Capacitance (pF)	E → 最大直径代码, 具体见下表 Maximum diameter code, see the table below					
10(100)	E			E		
12(120)	E			E		
15(150)	F			F		
18(180)	F			F		
20(200)	F			G		
22(220)	F			G		
24(240)	G			G		
27(270)	H			I		
30(300)	H			E		
33(330)	E			E		
36(360)	E			E		
39(390)	E			F		
43(430)	E			F		
47(470)	F			G		
51(510)	F			G		
56(560)	G			H		
62(620)	G			H		
68(680)	H			I		
75(750)	I			I		
82(820)	I			J		
91(910)	J			K		
100(101)	J/E			K/E		
120(121)	E			E		
150(151)	E			E		
180(181)	E			E		
200(201)	E			E		
220(221)	E			F		
240(241)	E			F		
270(271)	E			F		
300(301)	E			G		
330(331)	E			G		
360(361)	E			G		
390(391)	E			G		
470(471)	F	E		H	E	
560(561)	G	E		I	E	
680(681)	H	E		J	G	
820(821)	J	E		K	G	
1000(102)	J	F	E	L	H	E
1500(152)		H	F		J	G
2200(222)		J	G		L	J
3300(332)		L	H		N	K
4700(472)		N	K		P	M
6800(682)		Q	M			
10000(103)		R	O			
15000(153)						
误差 Tolerance	±5% / ±10% (J) / (K)	±20% (M)	±20% (M)	±5% / ±10% (J) / (K)	±20% (M)	±20% (M)
T, mm max.	4.5	5.0	5.0	5.0	5.5	5.5
F, ±0.8mm	7.5	7.5	7.5	10.0	10.0	10.0
ød, ±0.05mm	0.55	0.55	0.55	0.55	0.55	0.55
L, mm min	20.0	20.0	20.0	20.0	20.0	20.0

最大直径代码表 Maximum diameter code sheet

代码 Code	D	E	F	G	H	I	J	K	L	M	N	O	P	Q	R
D, mm max	6.5	7.0	7.5	8.0	8.5	9.0	10.0	11.0	12.0	13.0	14.0	15.0	16.0	18.0	20.0

备注: 所有的尺寸规格均可以定制, 但需要向我公司业务咨询。
Note: All dimensions can be customized, but you need to consult with our sales staff.

标准与试验方法

SPECIFICATIONS AND TESTING METHODS

序 No.	试验项目 Item	标准 Specifications	试验方法 Testing methods					
1	外观与尺寸 Appearance (APP) and dimension	外观形状没有明显的缺点，尺寸在标准范围内。 No marked defect on appearance form and dimensions are within specified range.	电容必须用目视检查其明显的缺点。 The capacitor should be visually inspected for evidence of defect. 尺寸用游标卡尺测量。 Dimensions should be measured with slide calipers.					
2	标志 Marking	清晰易于识别。 To be easily legible.	目视检查。 The capacitor should be visually inspected.					
3	容量 Capacitance (C_n)	在误差范围内。 Within specified tolerance.	容量与损耗在 $25^\circ\text{C} \pm 1^\circ\text{C}$ 下，使用1kHz(100pF以下者使用1MHz)和1Vrms下测量。 The capacitance, $\tan\delta$ should be measured at $25^\circ\text{C} \pm 1^\circ\text{C}$ with 1kHz (<100pF: 1MHz) and 1.0V (r.m.s.).					
4	损耗角正切 Tangent of loss angle ($\tan\delta$)	<0.025						
5	绝缘电阻 Insulation resistance (IR)	$>10\ 000\text{M}\Omega$	在两导线间施加500VDC进行测量，时间不超过1分钟。 The insulation resistance should be measured with a DC 500V at normal temperature and humidity and less than 1 min. of charging. 测试电压应用在电容时必须通过1M Ω 的电阻。 The voltage should be applied to the capacitor through a resistor of 1M Ω .					
6	导线间 Between lead wires	无失效。 No failure.	在电容器两导线间施加表1测试电压60s后不被破坏(充/放电电流不大于50mA)。 The capacitor should not be damaged when test voltages of table 1 are applied between the lead wires for 60 sec. (Charge/Discharge current $\leq 50\text{mA}$)					
	本体绝缘 Body insulation	无失效。 No failure.	首先，将电容器的端子拧在一起，然后如图1所示，将金属箔包住电容器离端子3mm-4mm的本体，接着将电容器插入盛着直径为1mm的金属球的容器中，最后施加表1所示的AC电压60秒种。 First, the terminals of the capacitor should be connected together. Then, as shown in figure 1, a metal foil should be closely wrapped around the body of the capacitor to the distance of about 3mm to 4mm from each terminal. Then, the capacitor should be inserted into a container filled with metal balls of about 1mm diameter. Finally, AC voltage of table 1 is applied for 60 sec. between the capacitor lead wires and metal balls.  表1. Table 1. <table border="1" data-bbox="750 1097 1085 1187"> <thead> <tr> <th>类别 Type</th> <th>Y1</th> <th>Y2</th> </tr> </thead> <tbody> <tr> <td>耐电压 Voltage proof</td> <td>4000Vac</td> <td>2500Vac</td> </tr> </tbody> </table>	类别 Type	Y1	Y2	耐电压 Voltage proof	4000Vac
类别 Type	Y1	Y2						
耐电压 Voltage proof	4000Vac	2500Vac						
7	导线抗张强度 Terminal tensile strength	导线无折断，电容无破损。 Lead wire should not be cut off. Capacitor should not be broken.	固定电容器的本体，使电容器每支导线均承受10N垂直力，保持 10 ± 1 秒种。 Fix the body of the capacitor and apply a tensile weight gradually to each lead wire in the radial direction of the capacitor up to 10N and keep it for 10 ± 1 sec.					
8	导线抗折强度 Terminal bending strength	导线无折断，电容无破损。 Lead wire should not be cut off. Capacitor should not be broken.	电容器导线应承受5N重量，然后向外弯折成90°，然后回复到原来位置；接着往反方向弯折90°，再复原；弯折一次2-3秒种。 Each lead wire should be subjected to 5N weight and then a 90° bend, at the point of egress, in one direction, return to original position, and then apply a 90° bend in the opposite direction at the rate of one bend in 2 to 3 sec.					
9	可焊性 Solderability of Leads	导线必须有3/4以上的面积均匀附着焊锡。 Lead wire should be soldered with uniform coating on the axial direction over 3/4 of the circumferential direction.	将电容器的导线浸入焊料中 2 ± 0.5 秒种，浸入深度离导线根部1.5-2.0mm。 The lead wire of a capacitor should be dipped into molten solder for 2 ± 0.5 sec. The depth of immersion is up to about 1.5 to 2.0mm from the root of lead wires. 焊锡温度：无铅焊锡 (Sn-3Ag-0.5Cu) $245 \pm 5^\circ\text{C}$ 易溶解的H63号锡 (Pb37/Sn63) $235 \pm 5^\circ\text{C}$ Temp. of solder: Lead Free Solder (Sn-3Ag-0.5Cu) $245 \pm 5^\circ\text{C}$ H63 Eutectic Solder (Pb37/Sn63) $235 \pm 5^\circ\text{C}$					
10	耐焊接热 Soldering effect	APP	没有可见损伤 No marked defect					
		$\Delta C/C$	Y5P: $\pm 10\%$ Y5U, Y5V: $\pm 20\%$					
		IR	$>1\ 000\text{M}\Omega$					
		WV	如第6项 Per Item 6					
11	振动 resistance	APP	没有可见损伤 No marked defect					
		C_n	在误差范围内。 Within specified tolerance.					
		$\tan\delta$	如第4项 Per Item 4					

Note: $\Delta C/C = \frac{\text{Post-test } C_n - \text{Pre-test } C_n}{\text{Pre-test } C_n} \times 100\%$

标准与试验方法 SPECIFICATIONS AND TESTING METHODS

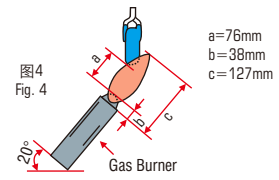
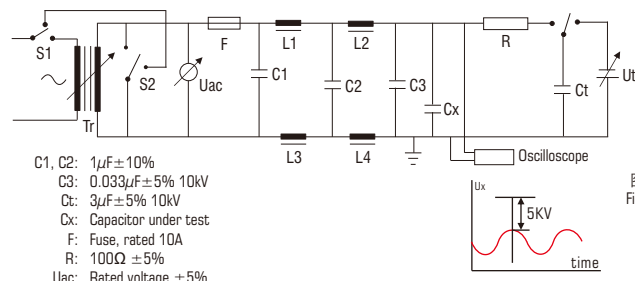
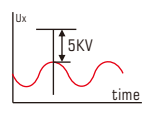
序 No.	试验项目 Item	标准 Specifications	试验方法 Testing methods						
12	耐湿负荷 Humidity Loading	APP 没有可见损伤 No marked defect	电容保持在温度为 $40 \pm 2^\circ\text{C}$ 、相对湿度为90-95%条件下施加额定电压500 \pm 12小时。 Apply the rated voltage for 500 ± 12 hrs. at $40 \pm 2^\circ\text{C}$ in 90 to 95% relative humidity. 试验后处理: Post-treatment: 电容必须贮存在室温条件下一至二小时。 Capacitor should be stored for 1 to 2 hrs. at room condition.						
		$\Delta C/C$ Y5P: $\pm 10\%$ Y5U, Y5V: $\pm 15\%$							
		$\tan\delta$ <0.050							
		IR >3 000M Ω							
		WV 如第6项 Per Item 6							
13	寿命试验 Life Test	APP 没有可见损伤 No marked defect	首先, 每个供试验电容必须承受5kV (Y1为8kV) 脉冲电压冲击三次, 然后再进行寿命试验。 Frist, Each individual capacitor should be subjected to a 5kV (8kV for Y1) impulses for three times. After the capacitors are applied to life test. 然后在 $125 \pm 2/0^\circ\text{C}$ 和相对湿度不超过50%的条件下使用表2所要求的电压进行1000小时。 Then, apply a voltage of table 2 for 1000 hrs. at $125 \pm 2/0^\circ\text{C}$, and relative humidity of 50% max. 表2. 应用电压 Table 2. Applied Voltage 施加1.7倍额定电压, 另在每小时将电压增加AC1000V, 时间0.1秒, 170% of rated voltag except that once each hour the voltage is increased to AC1000V(r.m.s.) for 0.1 sec. 试验后处理 Post-treatment: 电容必须贮存在室温条件下一至二小时。 Capacitor should be stored for 1 to 2 hrs. at room condition.						
		$\Delta C/C$ Y5P: $\pm 10\%$ Y5U, Y5V: $\pm 15\%$							
		IR >3 000M Ω							
		WV 如第6项 Per Item 6							
14	针焰试验 Flame Test	电容离开火焰后自动熄灭。 The capacitor flame discontinues as follows.	电容应放在火焰中15秒钟, 然后离开15秒钟, 如此重复5次。 The capacitor should be subjected to applied flame for 15 sec. and then removed for 15 sec. until 5 cycles are completed. 表3. Table 3. <table border="1" data-bbox="750 1153 949 1254"> <thead> <tr> <th>周期 Cycle</th> <th>1~4</th> <th>5</th> </tr> </thead> <tbody> <tr> <td>时间(秒) Time (sec)</td> <td>30</td> <td>60</td> </tr> </tbody> </table>	周期 Cycle	1~4	5	时间(秒) Time (sec)	30	60
		周期 Cycle		1~4	5				
时间(秒) Time (sec)	30	60							
	 <p>图4 Fig. 4 a=76mm b=38mm c=127mm Gas Burner</p>								
15	自燃性 Active Flammability	纱布不着火 The cheese-cloth should not be on fire.	单个电容器应用纱布全部包住至少一层, 但不多于两层。电容应承受放电20次, 每次放电间隔5秒钟。AC电源应维持两分钟, 最后放电。 The capacitor should be individually wrapped in at least one but not more than two complete layers of cheese-cloth. The capacitor should be subjected to 20 discharges. The interval between successive discharges should be 5 sec. The UAC should be maintained for 2 min. after the last discharge.  <p>图5 Fig. 5 Ux 5kV time</p>						
				C1, C2: $1\mu\text{F} \pm 10\%$ C3: $0.033\mu\text{F} \pm 5\%$ 10kV Ct: $3\mu\text{F} \pm 5\%$ 10kV Cx: Capacitor under test F: Fuse, rated 10A R: $100\Omega \pm 5\%$ Uac: Rated voltage $\pm 5\%$ Ut: Voltage applied to Ct. L1 TO L4: $1.5\text{mH} \pm 20\%$ 16A Rod core choke					
16	阻燃性 Passive Flammability	燃烧时间不超过30秒, 棉纸不被点燃。 The burning time should not exceed 30 sec. The tissue paper should not ignite.	电容器在下面试验中, 火焰在适当的位置被最大燃烧, 各个试验样品应只承受一次燃烧, 燃烧时间: 30秒钟。 The capacitor under test should be held in the flame in the position which best promotes burning. Each specimen should only be exposed once to the flame. Time of exposure to flame: 30 sec.  <p>图6 Fig. 6 About 8mm Test specimen 45° 200\pm5mm Tissue About 10mm thick board Length of flame: $12 \pm 1\text{mm}$ Gas burner : Length 35mm min. Inside dia. $0.5 \pm 0.1\text{mm}$ Outside dia. 0.9mm max. Gas : Butane gas purity 95% min.</p>						

标准与试验方法 SPECIFICATIONS AND TESTING METHODS

序 No.	试验项目 Item	标准 Specifications	试验方法 Testing methods															
17	温度特性 Temperature characteristics	Y5P: $\pm 10\%$ Y5U: $+22\%/ -56\%$ Y5V: $+22\%/ -82\%$	<p>电容器必须按照表4中的每一步骤进行测量。 The capacitance measurement should be made at each step specified in table 4.</p> <p>表4. Table 4.</p> <table border="1"> <thead> <tr> <th>步骤 Step</th> <th>1</th> <th>2</th> <th>3</th> <th>4</th> <th>5</th> </tr> </thead> <tbody> <tr> <td>温度 Temperature ($\pm 2^\circ\text{C}$)</td> <td>$+20^\circ\text{C}$</td> <td>-25°C</td> <td>$+20^\circ\text{C}$</td> <td>$+85^\circ\text{C}$</td> <td>$+20^\circ\text{C}$</td> </tr> </tbody> </table> <p>在温度特性试验过程中, 测量电容量时应注意电容器达到热稳定后方可进行。 In the temperature characteristics of the test process, capacitance measurements shall be made at each of the temperatures specified above, after the capacitor has reached thermal stability. 在不小于5分钟的时间间隔所取得的两次电容量的读数之差大于认为由测量仪表所引起的误差时, 才可判定为达到了热稳定状态。 The condition of thermal stability is judged as having been reached when two readings of capacitance taken at an interval of not less than 5 min do not differ by an amount greater than that which can be attributed to the measuring apparatus. 在测量期间必须注意防止电容器表面上凝露或结霜。 Care must be taken during measurements to avoid condensation or frost on the surface of the capacitors.</p>	步骤 Step	1	2	3	4	5	温度 Temperature ($\pm 2^\circ\text{C}$)	$+20^\circ\text{C}$	-25°C	$+20^\circ\text{C}$	$+85^\circ\text{C}$	$+20^\circ\text{C}$			
步骤 Step	1	2	3	4	5													
温度 Temperature ($\pm 2^\circ\text{C}$)	$+20^\circ\text{C}$	-25°C	$+20^\circ\text{C}$	$+85^\circ\text{C}$	$+20^\circ\text{C}$													
18	温度循环 Temperature cycle	<p>APP 没有可见损伤 No marked defect</p> <p>$\Delta\text{C}/\text{C}$ Y5P: $\pm 10\%$ Y5U, Y5V: $\pm 15\%$</p> <p>$\tan\delta$ < 0.050</p> <p>IR $> 3\ 000\text{M}\Omega$</p> <p>WV 如第6项 Per Item 6</p>	<p>电容器应承受五次温度循环。 The capacitor should be subjected to 5 temperature cycles.</p> <p>表5. 温度循环 Table 5. Temperature cycle</p> <table border="1"> <thead> <tr> <th>步骤 Step</th> <th>1</th> <th>2</th> <th>3</th> <th>4</th> </tr> </thead> <tbody> <tr> <td>温度 Temperature</td> <td>$-25^\circ\text{C} + 0^\circ\text{C} - 3^\circ\text{C}$</td> <td>室温 Room temp.</td> <td>$+125^\circ\text{C} + 3^\circ\text{C} - 0^\circ\text{C}$</td> <td>室温 Room temp.</td> </tr> <tr> <td>时间 Time</td> <td>30 min</td> <td>3 min</td> <td>30 min</td> <td>3 min</td> </tr> </tbody> </table> <p>预处理 Pre-treatment: 电容器必须先贮存于$85^\circ\text{C} \pm 2^\circ\text{C}$条件下1小时, 然后在室温下存放$24 \pm 2$小时, 再进行初始测量。 Capacitor should be stored at $85^\circ\text{C} \pm 2^\circ\text{C}$ for 1 hr., then placed at room condition for 24 ± 2 hrs. 试验后处理 Post-treatment: 电容必须贮存于室温条件下24 ± 2小时。 Capacitor should be stored for 24 ± 2 hrs. at room condition.</p>	步骤 Step	1	2	3	4	温度 Temperature	$-25^\circ\text{C} + 0^\circ\text{C} - 3^\circ\text{C}$	室温 Room temp.	$+125^\circ\text{C} + 3^\circ\text{C} - 0^\circ\text{C}$	室温 Room temp.	时间 Time	30 min	3 min	30 min	3 min
步骤 Step	1	2	3	4														
温度 Temperature	$-25^\circ\text{C} + 0^\circ\text{C} - 3^\circ\text{C}$	室温 Room temp.	$+125^\circ\text{C} + 3^\circ\text{C} - 0^\circ\text{C}$	室温 Room temp.														
时间 Time	30 min	3 min	30 min	3 min														

标志 MARKING

产品标志内容如下图所示:

The contents of the product marking are as shown below:

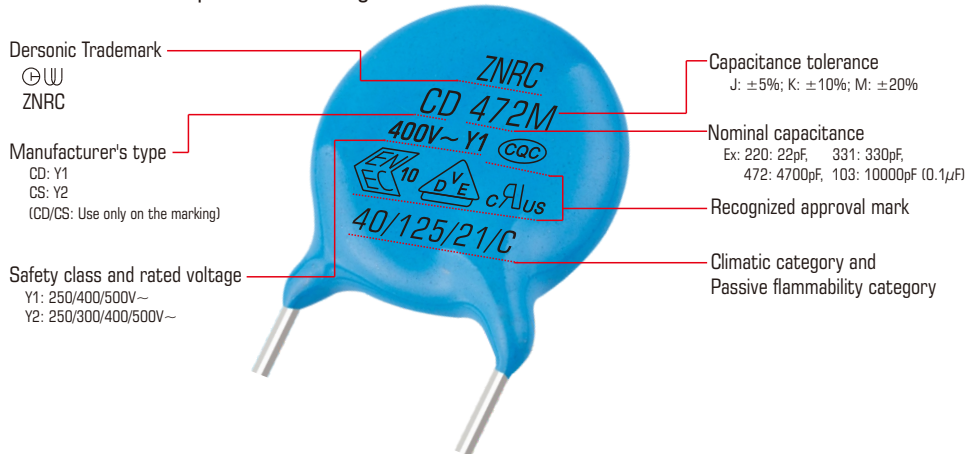

包装 PACKAGING

■ 散件包装 Bulk packing

散件包装最小包装为PE袋，其包装数量如下表所示；一定数量的最小包装装入内盒中，最后4个小盒或10个小盒，装入大箱中，具体由产品规格确定。

The minimum packing of bulk packaging is PE bag, the packing quantity is shown in the following table; a certain number of minimum packaging into the inner box, the last 4 inner boxes or 10 inner boxes, loaded into the outer box, specifically determined by the product specifications.

额定电压 Rated voltage	脚长 Lead length	产品直径 Body diameter	最小包装数量 Minimum packaging quantity
<4kVdc	≤16mm	All	1 000
	>16mm	≤8.5mm	1 000
		>8.5mm	500
4kVdc (Y2)	≤16mm	All	500
	>16mm	≤8.5mm	1 000
		>8.5mm	500
>4kVdc (Y1)	≤16mm	All	500
	>16mm	≤8.5mm	1 000
		>8.5mm	500

■ 编带包装 Taping packing

编带尺寸规格见下一页，其包装盒或卷盘尺寸，及最小包装数量如下表所示

The taping specifications are shown on the next page, the dimensions of the ammo or reel, and minimum packaging quantity are shown in the following table

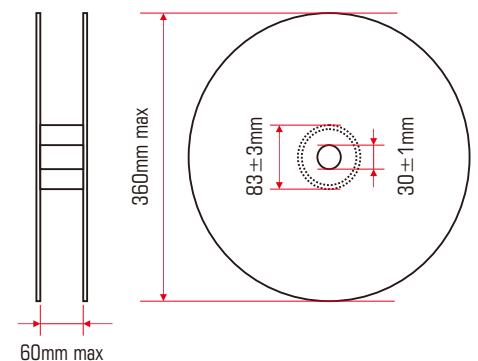
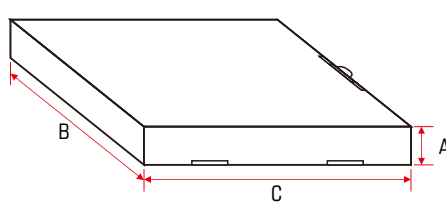
包装方式 Packaging format	卷盘包装 Reel packaging	折叠包装 Ammo packaging						
尺寸(mm)与图示 Dimensions (mm) and drawing		 <table border="1" data-bbox="989 1680 1404 1769"> <thead> <tr> <th>A</th> <th>B</th> <th>C</th> </tr> </thead> <tbody> <tr> <td>43±2mm</td> <td>256±5mm</td> <td>335±5mm</td> </tr> </tbody> </table>	A	B	C	43±2mm	256±5mm	335±5mm
A	B	C						
43±2mm	256±5mm	335±5mm						
包装数量(pcs) Quantity (pcs)	500~2 500 per reel	500~2000 per ammo						

卷盘包装一盘装四盒，每盒二盘；折叠包装一盒装十盒。

Reel packaging 4 boxes per carton, 2 reels per boxed; Ammo packaging 10 boxes per carton.

测量和使用注意事项 MEASURING AND APPLICATION NOTICE

1. 测量

Measurement

请在以下条件下测量。

Please measure under the following conditions.

1.1. 标准大气条件

Standard atmospheric conditions

除非另有规定，所有试验和测量应按在IEC 60068-1的5.3规定的试验用标准大气条件下进行：

Unless otherwise specified, all tests and measurements shall be made under standard atmospheric conditions for testing as given in IEC 60068-1, 5.3:

表1. 标准大气条件
Table 1. Standard atmospheric conditions

温度 Temperature	相对湿度 Relative humidity	气压 Air pressure
15°C~35°C	25%~75%	86kpa~106kpa

在进行测量之前，电容器应在测量温度下存放足够时间，以使整个电容器都达到这一温度。为此目的，规定与试验后恢复时间同样的时间，通常是足够的。

Before the measurements are made, the capacitor shall be stored at the measuring temperature for a time sufficient to allow the entire capacitor to reach this temperature. The period as prescribed for recovery at the end of a test is normally sufficient for this purpose.

在标准大气条件下进行测量，其测量结果存在争议时应采用仲裁温度（见1.3）重复测量。

Test and measurement shall be made under standard atmospheric conditions for testing, in the event of a dispute, the measurements shall be repeated using one of the referee temperatures (as given in 1.3).

当按某一顺序进行试验时，一个试验的最后测量可以作为下一试验的初始测量。

When tests are conducted in a sequence, the final measurements of one test may be taken as the initial measurements for the succeeding test.

在测量期间，不应使电容器受到气流、阳光直射或可能引起误差的其他影响。

During measurements the capacitor shall not be exposed to draughts, direct sunlight or other influences likely to cause error.

1.2. 恢复条件

Recovery conditions

除非另有规定，恢复应在试验用标准大气条件（见1.1）下进行。

Unless otherwise specified recovery shall take place under the standard atmospheric conditions for testing (1.1).

如果恢复必须在严格控制条件下进行，应采用IEC 60068-1中5.4.1的控制条件。

If recovery under closely controlled conditions is necessary, the controlled recovery conditions of 5.4.1 of IEC 60068-1 shall be used.

除非有关规范另有规定，恢复时间应为1h~2h。

Unless otherwise specified in the relevant specification, a duration of 1 h to 2 h shall be used.

1.3. 仲裁条件

Referee conditions

在仲裁情况下，应选用IEC 60068-1中5.2中规定的仲裁试验用标准大气条件。

For referee purposes, one of the standard atmospheric conditions for referee tests taken from 5.2 of IEC 60068-1, as given in table 1 below, shall be selected:

表2. 仲裁条件
Table 2. Referee conditions

温度 Temperature	相对湿度 Relative humidity	气压 Air pressure
24°C~26°C	48%~52%	86kpa~106kpa

2. 工作电压

Operating voltage

在交流电路或纹波电路中使用直流额定电压电容器时，请务必将外加电压的Vp-p值或包含直流偏置电压的Vo-p值维持在额定电压范围内。

When DC-rated capacitors are to be used in AC or ripple current circuits, be sure to maintain the Vp-p value of the applied voltage or the Vo-p which contains DC bias within the rated voltage range.

测量和使用注意事项 MEASURING AND APPLICATION NOTICE

若向电路施加电压，开始或停止时可能会因谐振或切换产生暂时的异常电压。请务必使用额定电压范围包含这些异常电压的电容器。

When the voltage is applied to the circuit, starting or stopping may generate irregular voltage for a transit period because of resonance or switching. Be sure to use a capacitor with a rated voltage range that includes these irregular voltages.

表3. 工作电压Vp-p
Table 3. Vp-p of operating voltage

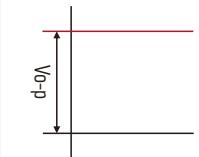
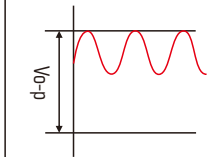
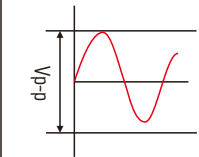
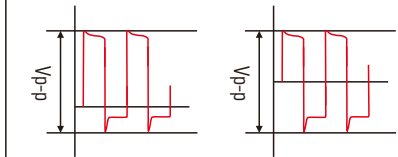
电压 Voltage	直流电压 DC Voltage	直流+交流电压 DC+AC Voltage	交流电压 AC Voltage	脉冲电压 Pulse Voltage
测量位置 Positional measurement				

3. 工作温度与自生热

Operating temperature and self-generated heat

适用于Hi-k类电容器

Apply to Hi-k type ceramic capacitors

电容器的表面温度应保持在额定工作温度范围的上限以下，务必考虑到电容器的自生热。

Keep the surface temperature of a capacitor below the upper limit of its rated operating temperature range. Be sure to take into account the heat generated by the capacitor itself.

电容器在高频电流、脉冲电流等中使用可能会因介电损耗发出自生热，所施加之正弦波电压的频率应低于300kHz。

When the capacitor is used in a high frequency current, pulse current or similar current, it may self-generate heat due to dielectric loss. The frequency of the applied sine wave voltage should be less than 300kHz.

外加电压应使自生热等负荷在25℃周围温度条件下不超过20℃范围。

The applied voltage load should be such that the capacitor's self-generated heat is within 20℃ in an atmosphere temperature of 25℃.

测量时应使用 $\varnothing 0.1\text{mm}$ 小热容量的(K)的热电偶，而且电容器不应受到其它元件的散热或周围温度波动影响(切勿在冷却风扇运转时进行测量。否则无法确保测量数据的精确性)。

When measuring, use a thermocouple of small thermal capacity-K of $\varnothing 0.1\text{mm}$ in conditions where the capacitor is not affected by radiant heat from other components or surrounding ambient fluctuations (Never attempt to perform measurement with the cooling fan running. Otherwise, accurate measurement cannot be ensured.).

过热可能会导致电容器特性及可靠性下降。

Excessive heat may lead to deterioration of the capacitor's characteristics and reliability.

使用低损耗电容器之前，一定要仔细阅读第4项的说明。

Before using the low loss type ceramic capacitors, be sure to read the instructions in item 4.

4. 在施加高频和高电压过程中的负荷降低与自生热

Load reduction and self-generated heat during application of high-frequency and high-voltage

由于低损耗电容器所具有的低自生热特性，此类电容器的允许电功率一般均高于Y5P特性电容器。但是，在峰间幅值等于电容器额定电压的高频电压条件下，当自热温度达到20℃时，电容器的功率消耗会超过其允许电功率。Due to the low self-heating characteristics of low loss type ceramic capacitors, the allowable electric power of these capacitors is generally much higher than that of Y5P characteristic capacitors. However, in case the self-heating temperature is 20℃ under a high-frequency voltage whose peak-to-peak value equals the capacitor's rated voltage, the capacitor's power consumption may exceed its allowable electric power.

因此，在将SL特性/低损耗系列电容器用在频率为1kHz或以上的高频高压电路中时，应确保包括直流偏压在内的Vp-p值不超过表4所规定之施加电压值。同时，还应确保25℃周围温度条件下的自生热温度(电容器表面温度与电容器周围温度之间的温度差)不超过表4所规定的温度值。

Therefore, when using the SL characteristic / low loss series in a high-frequency and high-voltage circuit with a frequency of 1kHz or higher, make sure that the Vp-p values including the DC bias, do not exceed the applied voltage value specified in Table 4. Also make sure that the self-heating temperature (the difference between the capacitor's surface temperature and the capacitor's ambient temperature) at an ambient temperature of 25℃ does not exceed the value specified in Table 4.

测量和使用注意事项
MEASURING AND APPLICATION NOTICE

表4. 高频状态下的允许条件
Table 4. Allowable Conditions at High frequency

系列 Series	温度特性 Temperature characteristic	直流额定电压 DC rated voltage	高频时允许条件 High-freq. allowable conditions		电容器周围温度 Capacitor's ambient Temp.
			外加电压(最大) Applied voltage (max)	自生热温度(周围温度25°C) Self-heating temp. (25°C ambient temp.)	
Hi-k	Y5R	1kV	800Vp-p	20°C max	-25°C~+85°C (如果周围温度在85至125°C之 间, 则应进一步降低所施加的 电压。 When the ambient temperature is 85 to 125°C, the applied voltage needs to be further reduced.)
			1000Vp-p	5°C max	
		2kV	1400Vp-p	20°C max	
			2000Vp-p	5°C max	
		3.15kV	1600Vp-p	20°C max	
			3150Vp-p	5°C max	
TC	SL	1kV	1000Vp-p	5°C max	
		2kV	2000Vp-p	5°C max	
		3.15kV	3150Vp-p	5°C max	
		6.3kV	6300Vp-p	5°C max	

由于受谐波影响, 当外加电压为矩形或脉冲波电压(非正弦波电压)时, 电容器的自生热会高于以相同的基础频率施加之正弦波电压所获得的温度值。

Because of the influence of harmonics, when the applied voltage is a rectangular wave or pulse wave voltage (instead of a sine wave voltage), the heat generated by the capacitor is higher than the value obtained by application of the sine wave with the same fundamental frequency.

为了参考作粗略计算, 矩形波或脉冲波的容许电压大致等于基础频率的2倍正弦波允许电压。但是, 该允许电压随电压和电流波形的不同而有所变化。

Roughly calculated for reference, the allowable voltage for a rectangular wave or pulse wave corresponds approximately to the allowable voltage for a sine wave whose fundamental frequency is twice as large as that of the rectangular wave or pulse wave. This allowable voltage, however, varies depending on the voltage and current waveforms.

因此, 您一定要确保自生热温度不高于表4所规定的温度值。

Therefore, you are requested to make sure that the selfheating temperature is not higher than the value specified in Table 4.

5. 耐电压的测试条件

Test condition for withstanding voltage

5.1. 测试设备

Test equipment

交流耐压的测试设备应具有能够产生类似于50/60Hz正弦波的性能。如果施加变形的正弦波或超过规定电压值的过载电压后, 则可能会导致故障。

Test equipment for AC withstanding voltage should be used with the performance of the wave similar to 50/60Hz sine wave. If the distorted sine wave or overload exceeding the specified voltage value is applied, a defect may be caused.

5.2. 电压外加方法

Voltage applied method

使用耐电压时, 电容器的引线或端子应对耐电压测试设备的输出端连接牢固; 然后再将电压从近零增加到测试电压。

When the withstanding voltage is applied, capacitor's lead or terminal should be firmly connected to the output of the withstanding voltage test equipment, and then the voltage should be raised from near zero to the test voltage.

如果测试电压不从近零逐渐提高而是直接施加在电容器上, 则施加时应包含过零点。测试结束时, 测试电压应降到近零; 然后再将电容器引线或端子从耐电压测试设备的输出端取下。

If the test voltage without the raise from near zero voltage would be applied directly to capacitor, test voltage should be applied with the zero cross. At the end of the test time, the test voltage should be reduced to near zero, and then capacitor's lead or terminal should be taken off the output of the withstanding voltage test equipment.

如果测试电压不从近零逐渐提高而是直接施加在电容器上, 则可能会出现浪涌电压, 从而导致故障。

If the test voltage without the raise from near zero voltage would be applied directly to capacitor, the surge voltage may arise, and therefore, a defect may be caused.

过零点是指电压正弦波通过0V的位置。参见右图。

ZERO CROSS is the point where voltage sine wave passes 0V. See figure at right.

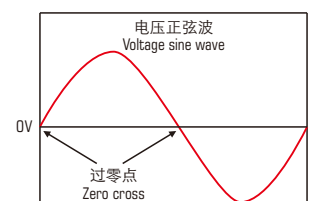

测量和使用注意事项 MEASURING AND APPLICATION NOTICE

6. 失效安全性

Fail-safe

电容器损坏时，失效可能会导致短路。为了避免在短路时引起触电、冒烟、火灾等危险情况，请在电路中使用熔丝等元件来设置自动防故障功能。

When capacitor would be broken, failure may result in a short circuit. Be sure to provide an appropriate fail-safe function like a fuse on your product if failure would result in an electric shock, fire or fuming.

7. 电容器容量变化

Capacitance change of capacitors

电容量可能会因环境温度或外加电压而发生轻微变化。若要将其用于严格的时间常数电路，请与我公司联系。
Capacitance might change a little depending on a surrounding temperature or an applied voltage. Please contact us if you use for the strict constant time circuit.

Hi-k类电容器具有老化特性；因此，电容器若长时间使用，其电容量会逐渐降低。而且，电容量还可能会因环境温度或外加电压而发生巨大变化。所以不适合用于时间常数电路。

Hi-k type ceramic capacitors have an aging characteristic, whereby the capacitor continually decreases its capacitance slightly if the capacitor is left on for a long time. Moreover, capacitance might change greatly depending on the surrounding temperature or an applied voltage. So, it is not likely to be suitable for use in a constant time circuit.

若需详情，请与我公司联系。

Please contact us if you need detailed information.

8. 使用设备进行性能检查

Performance check by equipment

使用电容器之前，请先检查设备的性能和特性没有问题。

Before using a capacitor, check that there is no problem in the equipment's performance and the specifications.

一般而言，Hi-k类电容器的电容量具有电压相关特性和温度相关特性。所以，其电容值可能会随设备的工作条件而发生变化。因此，一定要确认仪器接收性能对电容器的静电容量值变化的影响，如漏电流和静噪特性。

Generally speaking, Hi-k type ceramic capacitors have voltage dependence characteristics and temperature dependence characteristics in capacitance. So, the capacitance value may change depending on the operating condition in the equipment. Therefore, be sure to confirm the apparatus performance of receiving influence in the capacitance value change of a capacitor, such as leakage current and noise suppression characteristic.

此外，必要时还要检查电容器在设备中的防电涌性能，因为通过电路的感应，浪涌电压可能会超过规定值。

Moreover, check the surge-proof ability of a capacitor in the equipment, if needed, because the surge voltage may exceed specific value by the inductance of the circuit.

贮存条件

STORAGE ENVIRONMENT

电容器绝缘包封层不是完美的密封形式，因此，请勿将电容器存放在腐蚀性气体中，尤其是存在氯气、硫气、酸、碱、盐等场所，同时应防潮。

The insulating coating of capacitors does not form a perfect seal; therefore, do not use or store capacitors in a corrosive atmosphere, especially where chloride gas, sulfide gas, acid, alkali, salt or the like are present. And avoid exposure to moisture.

电容器应存放在温度及相对湿度分别不超出-10°C~40°C及15%~70%范围的场所。请在6个月内使用电容器。

Store the capacitors where the temperature and relative humidity do not exceed -10 to 40 degrees centigrade and 15% to 70%. Use capacitors within 6 months after delivered.

长时间保管（6个月以上）时，使用时请确认电容器的电容量及可焊性。

Before using the capacitors that has been stored for a long period (6 months or longer), confirm the capacitance and solderability.

焊锡和安装 SOLDERING AND MOUNTING

在对本产品进行清洗、焊接或成型前，请先在指定设备上测试经清洗、焊接或成型的产品的性能，以确定上述过程不会影响产品质量。

Before cleaning, bonding, or molding this product, verify that these processes do not affect product quality by testing the performance of a cleaned, bonded or molded product in the intended equipment.

使用时请勿使电容器或引线受到过度冲击或振荡；过度冲击或振荡对安装在电路板上的引线造成疲劳破坏。请采取措施，使用粘合剂、封膜树脂或其他涂层将电容器固定在电路板上；使用指定设备进行固定时，请确认固定措施对产品不会造成影响。

Do not expose a capacitor or its lead wires to excessive shock or vibration during use. Excessive shock or vibration may cause fatigue destruction of lead wires mounted on the circuit board. Please take measures to hold a capacitor on the circuit boards by adhesive, molding resin or another coating. Please confirm there is no influence of holding measures on the product with the intended equipment.

1. 焊锡

Soldering

当在PCB/PWB焊锡这个产品时，不要超过电容器的焊锡耐热性标准。过度的热量会使电容器内部焊锡熔化，可能导致热冲击而使陶瓷介质出现暗裂。When soldering this product to a PCB/PWB, do not exceed the solder heat resistance specifications of the capacitor. Subjecting this product to excessive heating could melt the internal junction solder and may result in thermal shocks that can crack the ceramic element.

当使用烙铁进行手工焊锡时，应该遵照下列条件：When soldering capacitor with a soldering iron, it should be performed in the following conditions.

焊锡温度：320°C最大

Temperature of iron-tip: 320°C. max.

烙铁头：不超过40W

Soldering iron wattage: 40W max.

焊锡时间：不超过3.0秒

Soldering time: 3.0 sec. max.

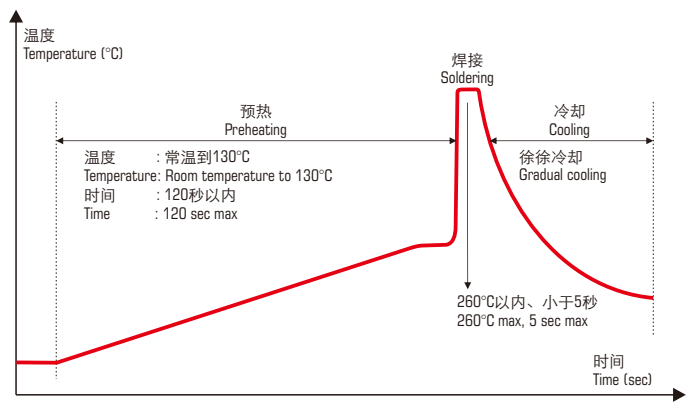

图：波峰焊接推荐条件

Fig.: Wave-soldering temperature-time profile to recommend

2. 压焊、树脂涂层与包封

Bonding, resin molding and coating

在压焊、树脂涂层和封膜之前，请先使用指定设备确认对产品没有影响，然后再进行使用。

Before bonding, molding or coating this product, verify that these processes do not affect the quality of capacitor by testing the performance of the bonded, molded or coated product in the intended equipment.

在粘合、树脂涂层、封膜的干燥、硬化条件使用到有机溶剂（乙酸乙酯、甲基乙酮、甲苯等），可能会破坏电容器的包封树脂，而造成短路不良。

In case the amount of applications, dryness / hardening conditions of adhesives and molding resins containing organic solvents (ethyl acetate, methyl ethyl ketone, toluene, etc.) are unsuitable, the outer coating resin of a capacitor is damaged by the organic solvents and it may result, worst case, in a short circuit.

粘合、树脂涂层、封膜厚度的偏差可能会在冷却与加热过程中使电容器的包封树脂和/或陶瓷介质破裂。

The variation in thickness of adhesive, molding resin or coating may cause outer coating resin cracking and/or ceramic element cracking of a capacitor in a temperature cycling.

3. 清洗（超声波清洗）

Cleaning (ultrasonic cleaning)

要进行超声波清洗，应遵守下列条件。

To perform ultrasonic cleaning, observe the following conditions.

清洗槽容量：每升输出功率20瓦特或以下。

Rinse bath capacity: Output of 20 watts per liter or less.

清洗时间：最多5分钟。

Rinsing time: 5 min. maximum.

不得直接振动 PCB/PWB。

Do not vibrate the PCB/PWB directly.

过度的超声波清洗会导致导线的过载损坏。

Excessive ultrasonic cleaning may lead to fatigue destruction of the lead wires.