



规格书  
SPECIFICATIONS

规格书编号/ID: M2629822015A  
物料描述/  
Product Description: 26.2982M 20PF 15PPM  
料号/  
Part Number: S47SMD26.2982M20PF15R30B3  
制作人/  
Approved by: 莫平会  
审核人/  
Checked by: 陈晓群  
日期/ 盖章/  
Date: 2022-12-29 Stamp: \_\_\_\_\_

客户签署/  
Customer signature required

公司名称/  
Company: \_\_\_\_\_

客户料号/  
Customer Part Number: \_\_\_\_\_

承认人/  
Approved by: \_\_\_\_\_

批准人/  
Confirmed by: \_\_\_\_\_

日期/  
Date: \_\_\_\_\_

盖章/  
Stamp: \_\_\_\_\_



四川索斯特电子有限公司  
Sichuan Source-Set Electronics Co., Ltd  
石英晶体规格书



**CRYSTAL UNIT SPECIFICATIONS**

一、电性能参数 ELECTRICAL PARAMETERS:

No.	特性 Characteristic	范围 Limits	备注 Remark
1	产品型号 Ackage Type	SST-M49SSMD	
2	标称频率 Nominal Frequency	26.2982MHz	
3	振动模式 Mode of Vibration	AT—Fund (基频)	
4	常温频差 Frequency Tolerance	±15ppm	25±3℃ 测试 Measure at 25℃±3℃
5	工作温度范围 Operating Temperature Range	-20℃~+70℃	
6	频率稳定度 Frequency Stability	±30ppm	
7	储存温度范围 Storage Temperature Range	-40℃~+85℃	
8	负载电容 Load capacitance	20pF	
9	谐振电阻 Equivalent Series Resistance	40 Ω max	
10	激励功率 Drive Level	100 μ W max	
11	绝缘电阻 Insulation Resistance	500M Ω	At 250V <sub>DC</sub>
12	静电容 Shunt Capacitance	5pF max	
13	年老化率 Aging Per Year	±5ppm	
14			
15			
16			
17			
18			

**CRYSTAL UNIT SPECIFICATIONS**

**二、可靠性试验 Reliability test**

No.	测试项目 Item	测试条件 Test Conditions	判定标准 Basis of Verdict
1	跌落冲击 Drop	75cm 高度自由下落到 3cm 厚度的硬质木板 3 次 3 Times Free Fall from 75cm height table to 3cm thickness hard wood board	$\Delta FL \leq \pm 5\text{ppm}$ , $\Delta R \leq 5\text{ohm or } \leq 10\%$
2	模拟回流焊 Reflow	$240^{\circ}\text{C} \leq T \leq 265^{\circ}\text{C}$ $t=60 \pm 30\text{s}$ $T=260^{\circ}\text{C} \pm 5^{\circ}\text{C}$ $t=40 \pm 10\text{s}$ $T(\text{max}) = 265^{\circ}\text{C}$	$\Delta FL \leq \pm 5\text{ppm}$ , $\Delta R \leq 5\text{ohm or } \leq 10\%$
3	可焊性 Solder	$260^{\circ}\text{C} \pm 5^{\circ}\text{C}$ 焊锡槽浸润 $3 \pm 0.5$ 秒 Temperature: $260^{\circ}\text{C} \pm 5^{\circ}\text{C}$ Time: $3 \pm 0.5$ Seconds	新锡覆盖率 $\geq 90\%$ the solder immersion surface $\geq 90\%$
4	耐焊接热 Solder Heating	$280^{\circ}\text{C} \pm 5^{\circ}\text{C}$ 焊锡槽浸润 $10 \pm 1$ 秒 Temperature: $280^{\circ}\text{C} \pm 5^{\circ}\text{C}$ Time: $10 \pm 1$ Seconds	$\Delta FL \leq \pm 5\text{ppm}$ , $\Delta R \leq 5\text{ohm or } \leq 10\%$
5	高温储存 High temperature storage	$100^{\circ}\text{C} \pm 2^{\circ}\text{C}$ 烘箱中烘烤 $96 \pm 1$ 小时 Temperature: $100^{\circ}\text{C} \pm 5^{\circ}\text{C}$ Time: $96 \pm 1$ Hours	$\Delta FL \leq \pm 5\text{ppm}$ , $\Delta R \leq 5\text{ohm or } \leq 10\%$
6	高温老化 High temperature ageing	$85^{\circ}\text{C} \pm 5^{\circ}\text{C}$ 之烘箱中烘烤 30 天 Temperature: $85^{\circ}\text{C} \pm 5^{\circ}\text{C}$ , Time: 30days	$\Delta FL \leq \pm 5\text{ppm}$ , $\Delta R \leq 5\text{ohm or } \leq 10\%$
7	低温储存 Low temperature storage	$-40^{\circ}\text{C} \pm 2^{\circ}\text{C}$ 环境中保持 $96 \pm 1$ 小时 Temperature: $-40^{\circ}\text{C} \pm 2^{\circ}\text{C}$ Time: $96 \pm 1$ Hours	$\Delta FL \leq \pm 5\text{ppm}$ , $\Delta R \leq 5\text{ohm or } \leq 10\%$
8	恒温恒湿 Humidity	在湿度为 90~95%, 温度为 $40 \pm 2^{\circ}\text{C}$ 环境中保持 96 小时 Temp: $40^{\circ}\text{C} \pm 2^{\circ}\text{C}$ , Humidity: 90~95% Times: 96 Hours	$\Delta FL \leq \pm 5\text{ppm}$ , $\Delta R \leq 5\text{ohm or } \leq 10\%$
9	振动 Vibration	频率: $10 \sim 50\text{Hz}$ , 幅度: $0.75\text{mm}$ 频率: $50\text{Hz} \sim 500\text{Hz}$ , 加速度幅度: $98\text{m/s}^2$ 周期: $10-500-10\text{Hz}$ , $15\text{min}$ 振动方向: X、Y、Z 振动时间: 每个方向 2 小时 Frequency: $10 \sim 50\text{Hz}$ , Amplitude: $0.75\text{mm}$ Frequency: $50 \sim 500\text{Hz}$ , Amplitude: $98\text{m/s}^2$ Cycle time: $10-500-10\text{H}$ , $15\text{min}$ Direction: X、Y、Z Duration: 2 Hours /direction	$\Delta FL \leq \pm 5\text{ppm}$ , $\Delta R \leq 5\text{ohm or } \leq 10\%$

**CRYSTAL UNIT SPECIFICATIONS**

三、外形尺寸 Outline Dimensions (unit: mm)

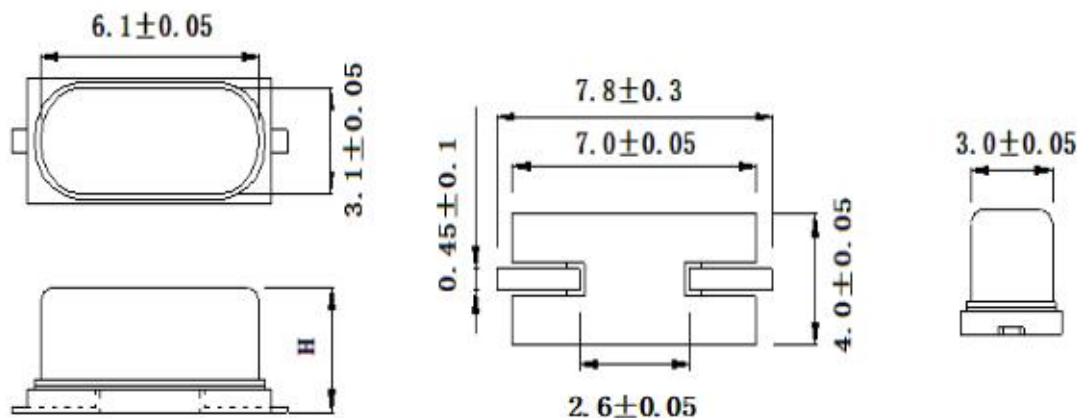

NO.	规格	H
1.	M49S -SMD	2.3Max
2.	M49S -SMD	2.1Max

四、印字 Marking

当前字样:



五、包装方式 Packing

T/R: 3000pcs/ REEL

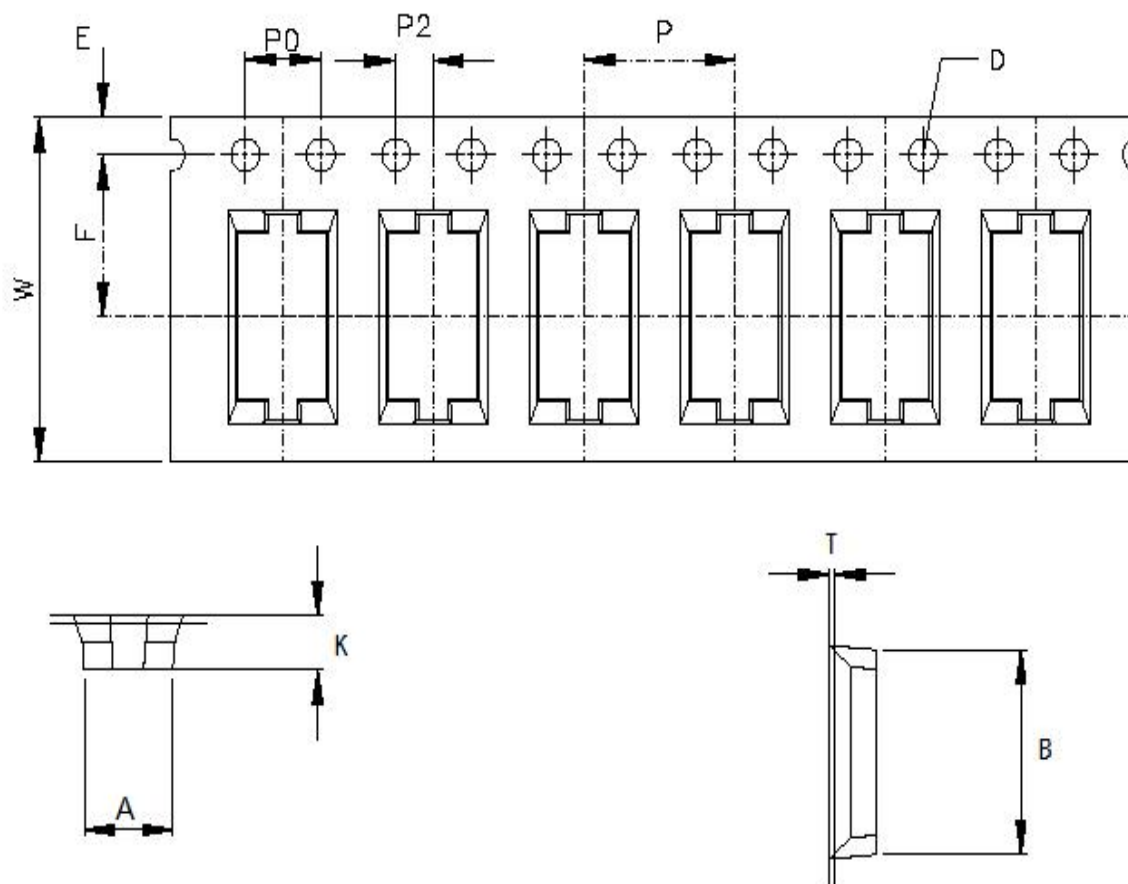

单位 units : mm:

Model	A	B	D	E	F	P	P0	T	W
SST-47SMD	4.7±0.1	9.5±0.1	Φ1.5	1.75±0.1	7.5±0.1	8.0±0.1	4.0±0.1	0.3±0.05	16±0.3

**CRYSTAL UNIT SPECIFICATIONS**

SPEC 1	12	16	24	32	44	56	72	88
C1±1	330	330	330	330	330	330	330	330
A±0.2	2.3	2.3	2.3	2.3	2.3	2.3	2.3	2.3
B±0.2	10.0	10.0	10.0	10.0	10.0	10.0	10.0	10.0
H+2.0	12.5	16.5	24.5	32.5	44.5	56.5	72.5	88.5
T±0.2	2.1	2.1	2.1	2.1	2.1	2.1	2.1	2.1
D±0.5	∅100	∅100	∅100	∅100	∅100	∅100	∅100	∅100

